

Engineering Fundamentals of Threaded Fastener Design and Analysis

By Ralph S. Shoberg, P.E.,
Director of Technology, PCB Load & Torque, Inc.

Table of Contents

1.0 Introduction: Engineering Fundamentals of the Tightening Process 3

 1.1 Energy Transfer..... 3

 1.2 Modeling the Tightening Process..... 3

 1.3 Where Does the Torque Go? 4

 1.4 Elastic Torque-Tension Relationship 5

 1.5 Stress/Strain vs. Torque/Tension 5

 1.6 Correlation of Stress-Strain and Turn 6

 1.7 Force-Deformation and Torque-Angle Diagrams 7

 1.8 Preload-Preload Efficiency Factor 7

 1.9 Torque-Tension Correlation Coefficient 8

 1.10 Thread/Underhead Friction Measurements 8

 1.11 Automated Tightening Process 9

2.0 Torque-Angle-Tension Control 9

 2.1 Introduction 9

 2.2 Torque-Angle-Signature 10

 2.3 Torque-Angle Signature Analysis 11

 2.3.1 Tightening Curve 12

 2.3.2 Elastic Origin 12

 2.3.3 Loosening Curve 12

 2.3.4 Beyond Yield 13

 2.3.5 Loosening Tendencies 13

 2.3.6 Accurate Measurement 13

 2.3.7 Torque-Angle Signature Analysis Summary 14

 2.4 Clamp Force/Strength Considerations 14

 2.5 Modeling the Tightening Process 14

 2.6 Torque-Tension Coefficient: Nut Factor, K 16

 2.7 Experimental Determination of Friction Coefficients 17

 2.8 Thread/Underhead Friction Coefficient Measurements 17

 2.9 M-Alpha Diagram 18

 2.10 FM-Alpha Diagram 19

 2.11 Estimating the Tension-Angle Coefficient 20

 2.11.1 Ultrasonic Stretch 20

 2.11.2 Strain-Gaged Bolt 20

 2.11.3 Force Washer 21

 2.11.4 Model-Calculation: Estimate of Angle-Tension Coefficient 21

 2.11.5 Laboratory Measurement of Friction Coefficients 22

 2.11.6 Material Property-Yield 23

 2.12 Torque-Angle Tension Control Summary 23

3.0 Torque-Tension Audits 25

 3.1 Introduction 25

 3.2 Hand Torque Audit-Tool Torque Capability 26

 3.3 Tool Torque Capability/ISO 5393 26

 3.4 Release Angle-Tension Audit 26

 3.5 Loosening-Embedment or Loss of Preload 29

 3.6 Measurements Verify Fastener Torque and Tension 29

4.0 Other Strategies 33

 4.1 Torque-Turn-To-Yield 33

 4.2 Prevailing Torque Locknut Signature Analysis 33

 4.3 Hand Torque Tightness Quality Audits 33

 4.3.1 Redefining The Audit 34

 4.3.2 Hand Torque Audit Qualification 36

5.0 Using Torque Angle Records to Determine Joint Stiffness 36

6.0 Material Yield Point 38

7.0 Glossary of Important Terms 38

8.0 References 39

1.0 Introduction: Engineering Fundamentals of the Tightening Process

The process of tightening threaded fastener assemblies, especially for critical bolted joints, involves controlling both input torque and angle of turn to achieve the desired result of proper preload of the bolted assembly. Understanding the role of friction in both the underhead and threaded contact zones is the key to defining the relationship between torque, angle, and tension.

There can be as many as 200 or more factors that affect the tension created in a bolt when tightening torque is applied (refer to paragraph 2.2). Fortunately, torque-angle signature curves can be obtained for most bolted joints.

By combining the torque-angle curves with a few simple calculations and a basic understanding of the engineering mechanics of threaded fasteners, you can obtain the practical information needed to evaluate the characteristics of individual fastener tightening processes. The torque-angle curves can also provide the necessary information to properly qualify the capability of tightening tools to properly tighten a given fastener.

1.1 Energy Transfer

Tightening threaded fasteners is basically an energy transfer process as shown in Figure 1. The area under the torque-angle curve is proportional to the energy required to tighten the fastener.

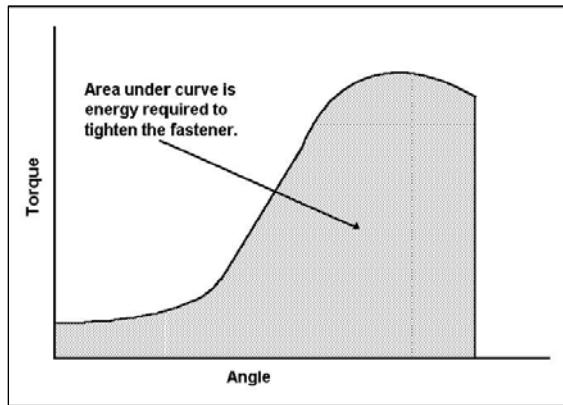

Figure 1 Tightening Fasteners Transfers Energy

1.2 Modeling the Tightening Process

Achieving proper control of the tightening process is possible only if you understand the relationship between torque and turn in the development of tension.

Before studying tightening methods, it is necessary to become familiar with what actually happens when a fastener is tightened. The process of tightening a fastener involves turning, advance of the lead screw,

and torque, turning moment, so that preload, tension, is produced in the fastener. The desired result is a clamping force to hold components together.

Figure 2. Four Zones of the Tightening Process

The most general model of the torque-turn signature for the fastener tightening process has four distinct zones as illustrated in Figure 2.

The first zone is the rundown or prevailing torque zone that occurs before the fastener head or nut contacts the bearing surface.

The second zone is the alignment or snugging zone wherein the fastener and joint mating surfaces are drawn into alignment to achieve a “snug” condition.

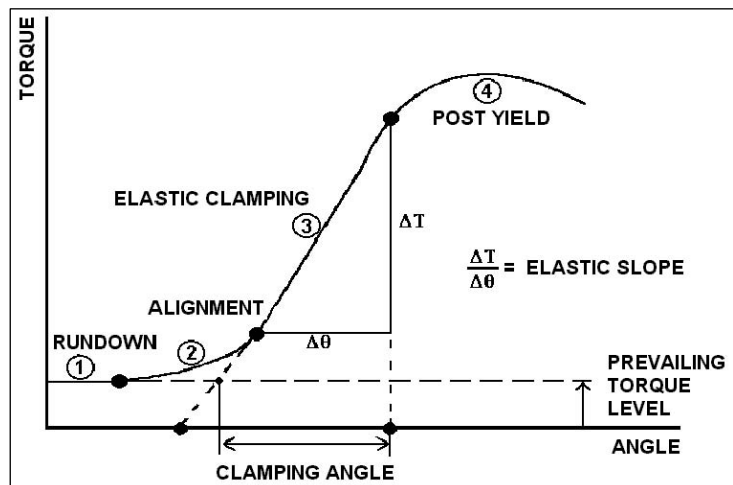

The third zone is the elastic clamping range, wherein the slope of the torque-angle curve is essentially constant.

The fourth zone is the post-yield zone, which begins with an inflection point at the end of the elastic range. Occasionally, this fourth zone can be due to yielding in the joint or gasket, or due to yield of the threads in the nut or clamped components or nut rather than to yield of the fastener.

NOTE: A more detailed discussion of the four tightening zones is presented in section 2.5.

In the special case where prevailing torque locking features are employed, the model includes an additional prevailing torque zone. In a more general sense, the prevailing torque can be the result of frictional drag on the shank or threads due to the misalignment of the parts, to chips or other foreign material in the threads, or due to out of tolerance threads with unintended interference.

The nonlinear alignment zone is a complex function of the process of drawing together of the mating threads, bending together of mating parts, and bending of the fastener as a result of non-parallelism of the bearing surface to the fastener underhead surface. These factors are referred to as macro effects. The alignment zone also has what is referred to as micro components. The micro effects include contact stress defections of plating and coatings as well as surface and thread deformations. These effects are illustrated in Figure 3.

Figure 3. Alignment Zone

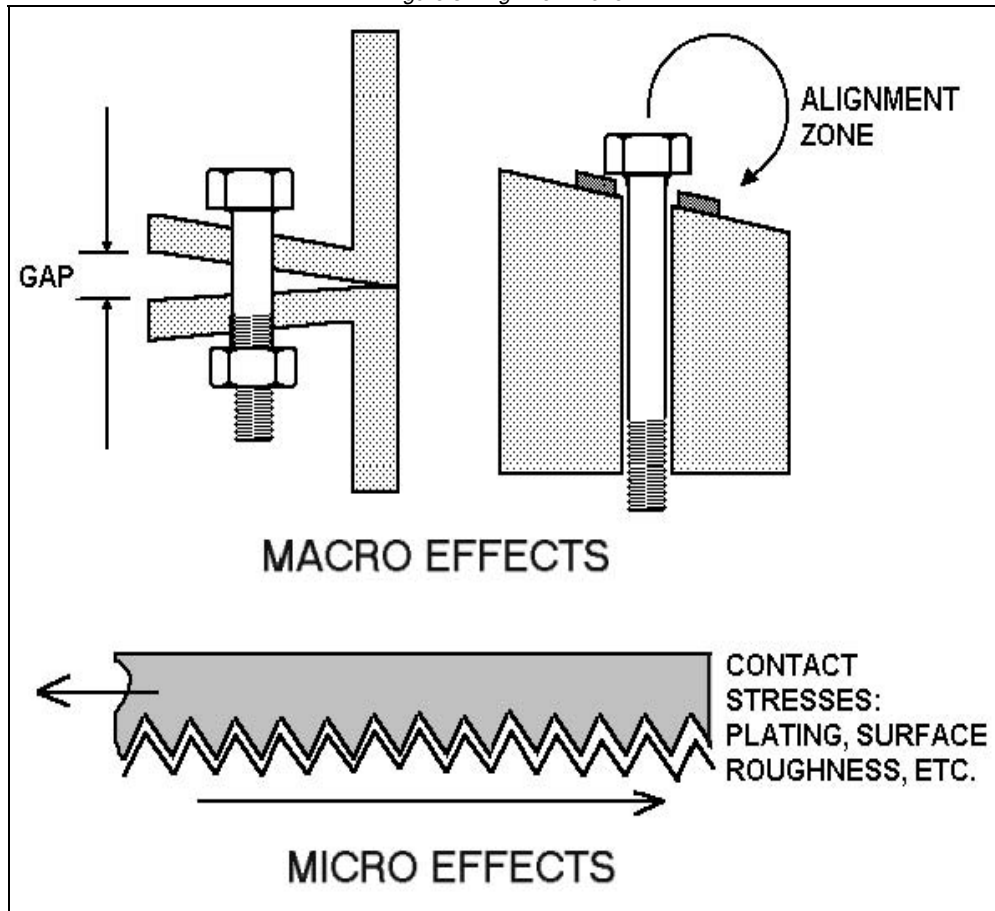

1.3 Where Does the Torque Go?

The basic torque distribution for a fastener is illustrated in Figure 4. The torque applied to a fastener is absorbed in three main areas. First, there is underhead friction, which may absorb 50 percent or more of the total torque. Thread friction absorbs as much as 40 percent of the applied torque. The final 10 percent

of the applied torque develops the clamping force that holds the components together. Thus an increase in either friction component of 5% can reduce tension by half.

Figure 4. Where Does the Torque Go?

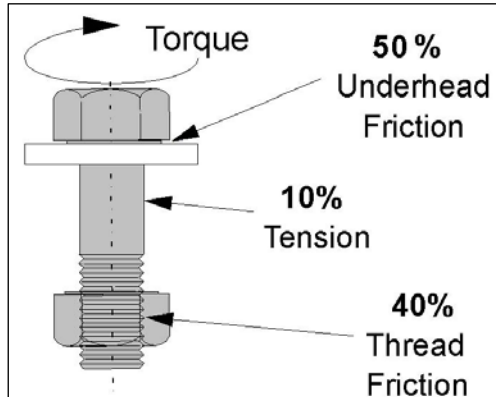

Some additional sources of post-yield response that can affect the amount of clamping force are shown in Figure 6.

Figure 6. Sources of Post-Yield Response

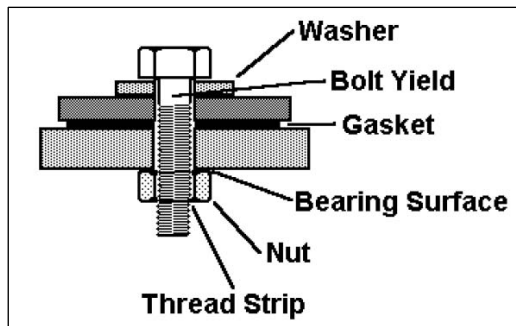

As shown previously, the area under the torque-angle curve represents the total energy required to tighten a fastener. As shown in Figure 5, the upper 10 percent of the area on the curve represents the elastic clamping energy that is providing the holding power to clamp the parts together. The elastic clamping energy shown on the torque-angle plot has the same value as the areas under the bolt and clamped component lines in the Force-Deformation Diagram (refer to Figure 9).

Figure 5. Where Does the Fastening Energy Go?

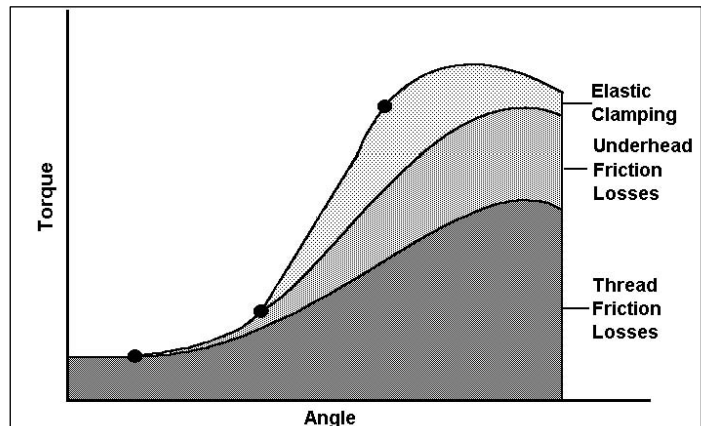

1.4 Elastic Torque-Tension Relationship

A practical starting point for all threaded fastener tightening analysis is to use the basic elastic torque-tension equation,

$T = K \cdot D \cdot F$, to estimate the relative magnitudes of torque and clamp force. Starting with this equation, which defines a linear relationship between torque and tension, you can develop models for the tightening process.

$$T = K D F$$

Where:

T = Torque (in-lb)

K = Nut Factor (Ranges from 0.03 to 0.35)

D = Nominal Diameter (inches)

F = Force (lb)

1.5 Stress/Strain vs. Torque/Tension

It is very helpful to picture the approximate equivalence of the stress-strain curve to the torque versus angle curve as illustrated in Figure 7 (note that the alignment zone has been removed from the torque-angle diagram). Deformation of the fastener and angle of turn are geometrically related by the following formula.

$$\delta = \frac{\alpha}{360} \times P$$

Where: δ = deformation

α = angle

P = pitch of thread

Figure 7. Relationship of Stress-Strain vs. Torque-Angle

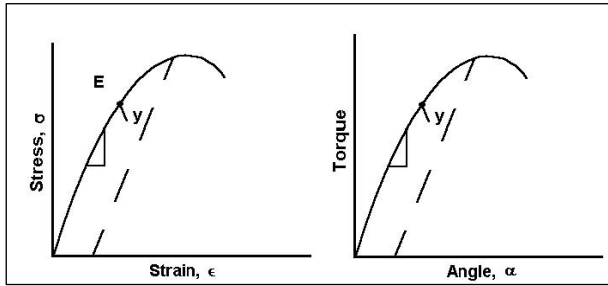

This relationship correlates directly with the stress-induced total strain in the fastener only when the fastener is tightened on a joint with infinite stiffness. Extensive testing has proven that the tension produced can be shown to be directly proportional to the angle of turn from the Elastic Origin. The elastic origin is located by projecting a line tangent to the elastic portion of the torque-angle curve backward to zero torque. The total angle of turn is equal to the compression of the clamped

components plus the stretch of the fastener as shown in Figure 8.

Figure 8. Angle of Turn is Proportional to Clamp Force

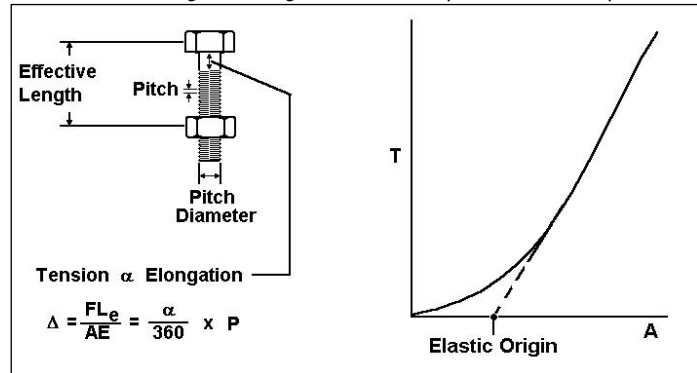

1.6 Correlation of Stress-Strain and Turn

The basic relationship of stress to strain in the elastic region is given by the following equation.

$$\sigma = \epsilon * E$$

Where: σ = Stress (psi)
 ϵ = strain (in/in)
 E = Young's Modulus (psi)

The stretch of a bolt or metal rod loaded in tension is calculated by use of the following equation.

$$\Delta = \frac{F * L}{A * E}$$

If the turn-to-tension procedure is used to establish clamping load, it is necessary to know both the spring rate of the bolt and the spring rate of the clamped components, since turning the bolt stretches the fastener and compresses the parts being clamped. A simple experimental procedure for estimating approximate joint and bolt stiffness is outlined in paragraph 5.0.

The slope of the Force-Angle of Turn relationship can be represented by the following equation.

$$\frac{\Delta F}{\Delta \Theta} = \left(\frac{K_b K_C}{K_B + K_C} \right) \frac{P}{360}$$

Where:

K_B = bolt spring rate (lb/in)
 K_C = joint spring rate (lb/in)

Taking the first derivative of the basic equation $T = K * D * F$ yields the following relationship.

$$\Delta T = K * D * \Delta F \text{ or } \Delta F = \frac{\Delta T}{K * D}$$

Substituting for ΔF in the Force-Angle of Turn equation results in a Torque-Angle slope equation shown below that can be used to estimate the spring rate of bolted joints.

$$\frac{\Delta T}{\Delta \Theta} = \left(\frac{K_B K_C}{K_B + K_C} \right) \frac{P * K * D}{360}$$

The spring rate of the bolt is estimated by the following equation.

$$K_B = \frac{F}{\Delta} \frac{L B}{\varepsilon} = \frac{A * E}{L_e}$$

Next, the slope of the elastic clamping region of the Torque-Angle Curve, $\Delta T/\Delta \Theta$, is determined from the curve. If a value for K is assumed, then the spring rate for the joint is calculated as follows.

$$K_C = \frac{\Delta T / \Delta \Theta}{\frac{K * D * P}{360} * K_B - \frac{\Delta T}{\Delta \Theta}} * K_B$$

1.7 Forcer-Deformation and Torque-Angle Diagrams

Similar to the correlation between the material Stress-Strain Diagram and the Torque-Angle Diagram, it is possible to illustrate correlation between the classic Force-Deformation Diagram and a special Torque-Angle Diagram shown in Figure 9. This special diagram illustrates the relative angular motion required to both stretch the fastener and compress the joint. The factors depicted in Figure 9 are identified in Table 1.

Figure 9. Force-Deformation and Torque-Angle Diagrams

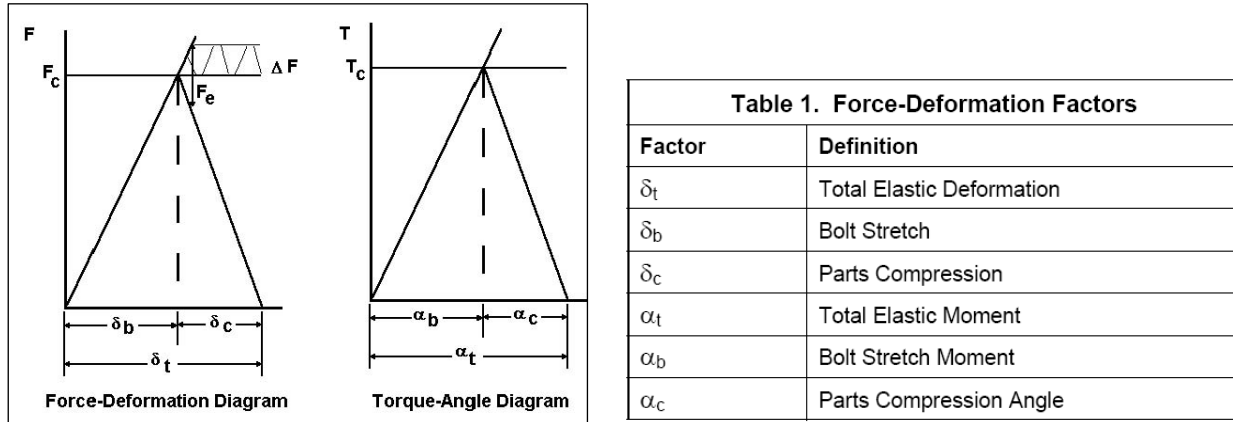

1.8 Preload-Preload Efficiency Factor

As can be seen from the Force-Deformation Diagram, the bolted joint responds in a predictable manner when subjected to external working loads. Preload efficiency factors, based upon the effective spring rates of the bolt and the clamped elements, are the key to analysis of the fatigue resistance safety factor. The Preload Efficiency Factor is determined using the following formula.

$$\Phi = \frac{K_B}{K_B + K_C}$$

With the aid of the torque-angle plot obtained from an actual assembly, it is possible to estimate the preload efficiency factor and calculate an approximate value for the effective spring rate for the clamped parts.

The accuracy of the calculated values for joint stiffness and clamping efficiency factor are dependent upon the degree of accuracy of the assumed value for K and the effective length, L_e , assumed for the bolt.

Where actual joint torque-angle records are available, the preload efficiency factor can be estimated by calculating the elastic angle of turn to stretch the bolt, α_b , and the angle of turn, α_c , over the same torque range needed to compress the joint.

$$\Phi = \frac{1}{1 + \frac{\alpha_b}{\alpha_c}}$$

Refer to paragraph 5.0 for a detailed derivation of this formula and a practical guide for use of torque angle records to estimate joint stiffness.

The Preload Efficiency Factor, Φ , when multiplied by the external applied load, is used to calculate the maximum change in bolt loading that can be expected when an external load is applied to the assembly. This is true only up to the point where the joint separates. Above the separation load, 100 percent of the external load goes directly on the bolt.

1.9 Torque-Tension Correlation Coefficient

The basic equation, $T = K D F$, applies to the linear elastic zone of the torque-angle tightening curve, after due consideration is given to the prevailing torque and alignment zone torque influences. The factor K, often referred to as the “nut factor,” can be expressed as a combination of three factors: K_1 , a geometric factor; K_2 , a thread friction related factor; and K_3 , an underhead friction related factor. Figure 10 shows the mathematical formulas for each of these factors.

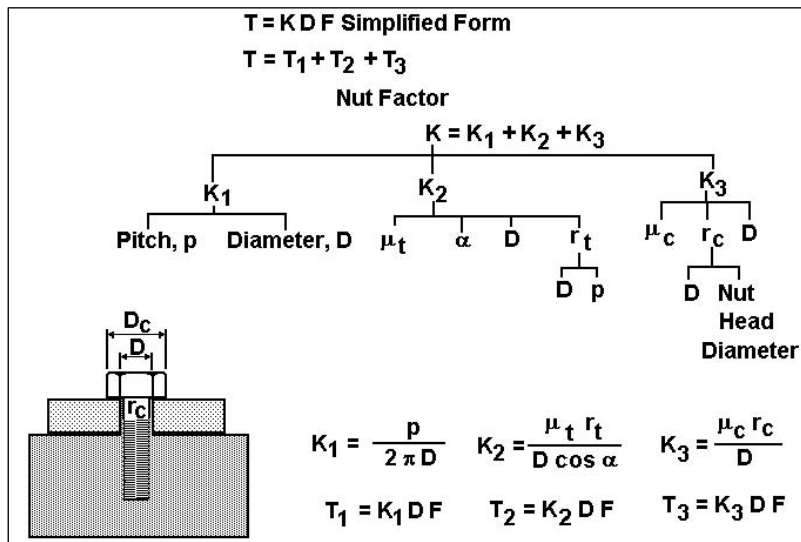

Figure 10. Frictional Coefficients

The friction coefficients μ_t and μ_c are key variables in the basic equation. While there are published tables for K (i.e., see Bickford), these are combined values. For more detailed analysis when designing special fasteners or solving a specific problem, it is often desirable or necessary to have more specific information on the underhead and thread friction factors.

It is possible to experimentally determine the underhead and thread friction coefficients. Using a specially designed torque-tension

load cell which measures clamp force and thread torque, it is possible to measure, study and analyze the frictional losses in the threads and underhead region of fasteners.

1.10 Thread/Underhead Friction Measurements

To insure overall reliable performance of threaded fasteners, it is necessary to control the frictional characteristics in both the thread and underhead regions. Achieving a specific clamp force during installation is always the desired result. However, the roll of thread and underhead friction must not be overlooked in preventing loosening.

In the development of fastener locking devices such as locknuts, serrated underheads, special thread forms, or thread locking compounds, it is essential that you have a means to measure both thread friction and underhead friction.

A Torque-Tension Research Head, as shown in cross-section in Figure 11, is a special load cell constructed to measure simultaneously thread torque, T_G , and clamp load, F_V . It is used along with the measurement of the input torque, T_A , to determine the underhead friction torque and the thread friction torque.

Figure 11. Torque-Tension Research Head

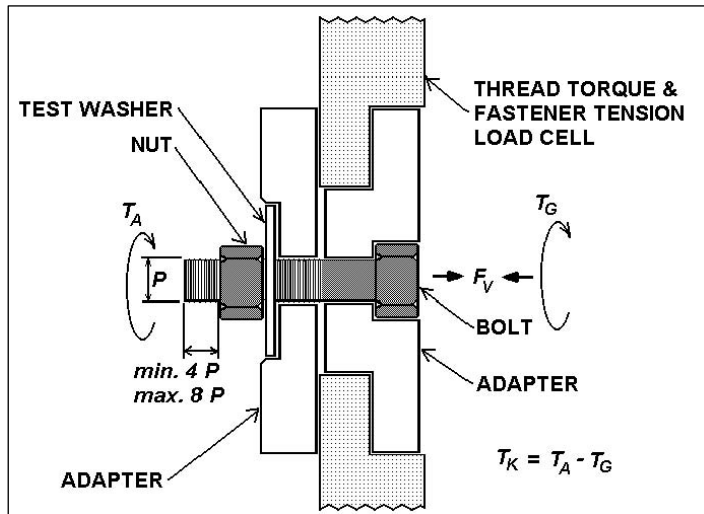

As clamp force is developed, the pitch torque is calculated and subtracted from the thread torque to compute the thread friction torque. Note that Pitch Torque = Pitch X Clamp Force/2 X π .

1.11 Automated Tightening Process

The capability of a power tool to deliver torque and turn to fasteners in a controlled fashion is the primary criteria for selection of tools for critical assembly operations. Torque-angle curves can be used to establish the energy transfer and control required from the tool. For the same maximum torque stiff-hard joints absorb less energy than soft highly compressible joints. Likewise long flexible fasteners absorb more energy than short stiff fasteners when torqued to the same values. Current industry practice involves use of air motors as well as energy efficient and highly controllable dc electric nutrunners. The various monitoring strategies include:

- Torque Monitoring
- Torque Monitoring with Control
- Torque-Angle Monitoring
- Torque-Angle Monitoring with Control
- Torque Rate Monitoring
- Yield Control (Variation of Rate Monitoring)

All of these processes are dependent upon measurement of the dynamic torque or torque and angle profiles during the tightening process.

2.0 Torque-Angle-Tension Control

The following paragraphs build on the concepts explained in the preceding section to further define torque-angle-tension control as the most significant method for determining joint integrity.

2.1 Introduction

It is possible for certain fasteners to be tightened with lower tension scatter by controlling tool shutoff at a specific angle of turn after a specified torque level is reached than would be attained if tightening had been done only with torque control. For this process to work reliably, it is necessary that the threshold torque that initiates the angle count to shutoff be set at a level above the alignment zone of the tightening

In the test plot, illustrated in Figure 12, the locknut is initially driven onto a bolt the thread friction torque is equal to the input torque until contact with the underhead-bearing surface is made. Once contact is made with the underhead area, the underhead friction torque is measured as the difference between the total input torque and the thread torque.

Figure 12. Determining Frictional Forces

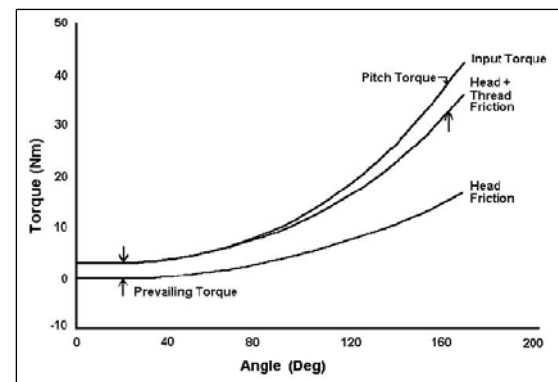

process. Figure 13 shows a clamp force scatter of 40 percent with torque control, reduced to 10 percent with torque-angle control.

When torque-only control is used as the method for tightening a fastener, there is absolutely no way to be 100 percent certain that the desired tension will be created. Using installation torque alone to control the process always introduces an element of “statistical gambling” into the assembly process. Installation torque measurements that are not backed up with simultaneous angle-of-turn measurements cannot be totally relied upon to insure that proper fastener installation has been accomplished.

For bolted joints where safety and reliable performance are dependent upon proper initial tension, both torque and angle-of-turn must be monitored and controlled during the tightening process. As each fastener is installed, the torque-angle tightening signature of the bolted joint should be compared to established assembly process limits to insure that the specified assembly preload has been achieved.

The fundamental tightening procedure for Torque-Angle-Tension Control is simply defined as follows.

1. Torque is applied until a specified “threshold” level is attained.
2. An additional angle-of-turn is applied to finish the installation.

The engineering analysis, test measurements, and installation methods outlined in this section can be applied to virtually any bolted joint. A unified approach, starting with basic assumptions, is used to develop a reliable torque-angle control procedure for achieving specified clamp loads.

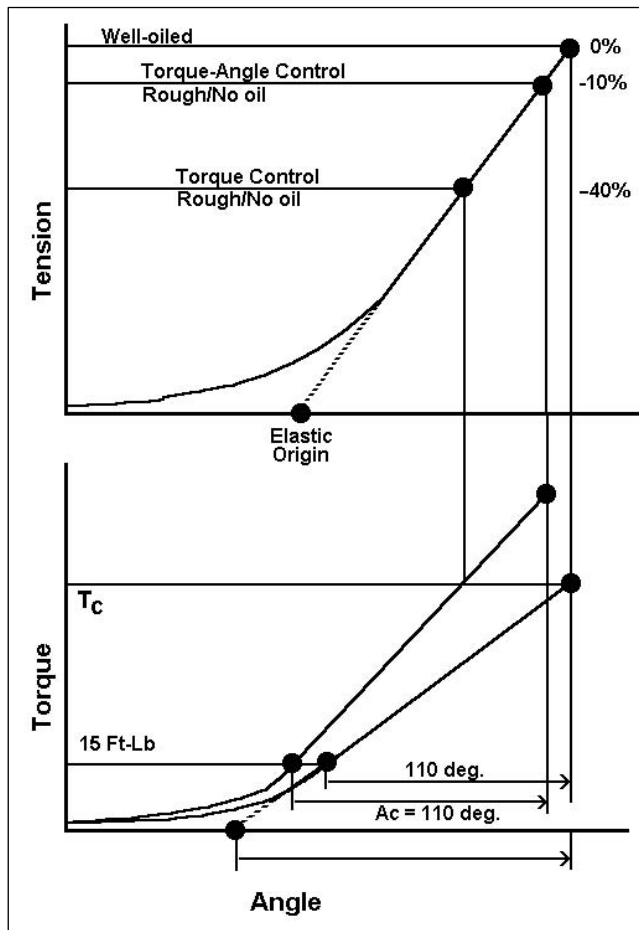

Figure 13. Torque Control vs. Torque-Angle Control

2.2 Torque-Angle Signature

The basic torque-angle signature is used as a starting point for all analysis. The influence of overhead and thread friction on the tightening process is easily illustrated by this model curve. An increase in friction, in either the thread or overhead regions, results in a proportional increase in the slope of the torque-angle signature. The angle-tension coefficient for each bolted joint must be determined in order to establish the control parameters for torque-angle-tension Control. The R_{FM} slope from the FM-Alpha (Clamping Force Angle) Diagram corresponds to the tension-angle coefficient for the tightening curve.

By shutting off the assembly tool at a specified angle-of-turn after the threshold torque is attained, the scatter in achieved tension will be much less than the scatter observed for the same fasteners tightened with torque-only control. For this process to work reliably, it is necessary that the threshold torque level for starting angle counting be set at a level which is above the alignment zone of the tightening process.

The curves in Figure 14 illustrate the basic principle of torque-turn-tension control. A key element in understanding how bolted joints function is the concept of the elastic origin, discussed previously.

Figure 14. Torque-Turn-Tension Control Principles

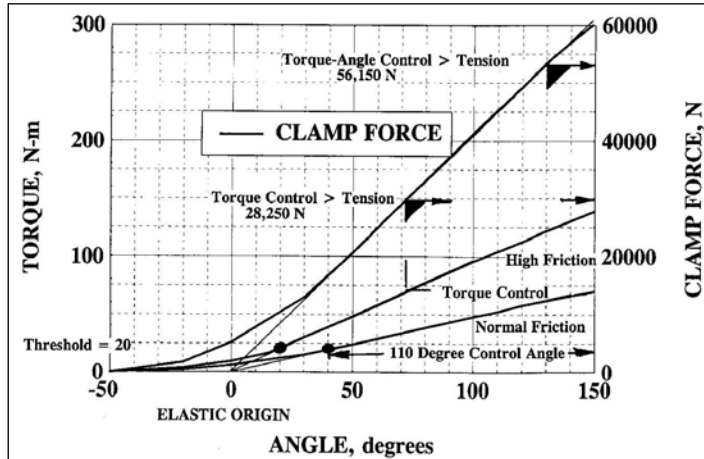

The elastic origin is located by projection of the tangent to the torque-angle signature curve to the zero torque or prevailing torque level. In the elastic tightening of the assembly process, bolt tension, or clamp force, is directly proportional to the angle-of-turn from the elastic origin.

A number of different methods can be used to determining the angle-tension coefficient for the bolted joint. A basic assumption is that as the fastener is turned to develop tension in the joint, the fastener stretches and the clamped parts compress elastically according to the effective spring rates of

the fastener and the clamped parts.

After the angle-tension coefficient is determined for elastic clamping, it is relatively easy to estimate the tension achieved when tightening beyond the bolt yield point¹.

After the installation process has been defined and implemented, methods must be specified to audit the results in order to verify that the process has achieved the desired fastener preload. Process audit procedures including the "Release Angle" measurement method and hand torque breakaway audits are presented in paragraph 3.0.

2.3 Torque-Angle Signature Analysis

Hand torque audits are conducted to verify the amount of torque that has been applied to a fastener. However, it is actually the tension or clamp force that determines whether the fastener has been properly tightened. Factors such as crossthreading can indicate a sufficiently high torque level while the clamp force is well below requirements.

A method of tightness verification called torque-angle signature analysis now provides a very practical and powerful technique for evaluating the actual clamp force achieved by a fastener installation process. Examining the torque-angle signature of a fastener basically means looking at tightening and loosening curves, or plots of torque versus angle, as the fastener is installed/uninstalled. These curves are studied initially in the elastic-tightening region where the fastener has not gone beyond yield.

The same test measurements used to establish the torque-angle process parameters can also be used as the basis for additional analysis. Torque-angle signatures can also be used to help verify joint strength, safety factors, and fatigue strength. They provide an extremely practical means to verify bolted joint design and engineering calculations. The M-alpha Diagram², presented in detail in paragraph 2.9, illustrates the effect of friction coefficients on the torque-angle signature. The effect of the thread friction coefficient on the clamp force developed at the onset of bolt yield is also clearly illustrated by use of the M-Alpha Diagram.

The following paragraphs discuss torque-angle signature analysis in more detail.

¹ The **yield point** must be analyzed to determine if the yield detected is in the bolt, or the joint, or possibly is a result of thread strip, or underhead embedment.

² The M-alpha Diagram was created in 1996 by Fritz Ruoss of HEXAGON and Ralph Shoberg of RS Technologies as an extension of the SR1-VDI 2230 Bolted Joint Design Software for Windows. See Appendix B for a Glossary of Terms for SR1-VDI 2230.

2.3.1 Tightening Curve

As described previously, the typical torque-angle tightening curve consists first of an aligning zone, which is a nonlinear or curved portion, where the fastener aligns parts and draws them together. Next is the elastic clamping zone, where the joint has been stabilized, the parts have been drawn together, and the fastener is snugging up the joint. This portion of the curve is a straight line or constant slope as shown in Figure 15.

Figure 15. Tightening Curve and Release Angle Audit Curve

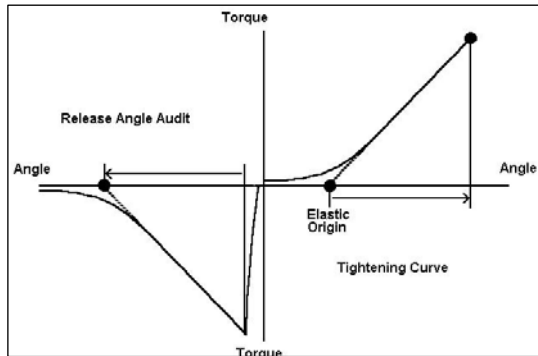

The fastener has been sufficiently snugged up when enough torque has been applied to the joint to get beyond the aligning zone so that it is in the elastic clamping zone.

2.3.2 Elastic Origin

Once torquing has been stopped in the elastic clamping zone, a line tangent to the straight-line portion of the curve can be projected backwards. The point where the projection line strikes zero torque, if there is no prevailing torque, is called the elastic origin. If the angle of turn is measured from the elastic origin to the point where

torquing was stopped in the elastic clamping zone, it will be found that the tension on the joint is directly proportional to that angle of turn. What is happening is that compression of the parts and stretching of the fastener is occurring in a linear fashion from the projected elastic origin. Even if friction on the threads or the underhead region of the fastener is varied, it still will be found that within the elastic region the tension generated is always proportional to the angle of turn from the elastic origin.

When studying a fastener where there is prevailing torque in the initial rundown, the line projected back along the elastic curve must stop at the prevailing level and the elastic origin will be set there rather than at zero torque. Then the tightening angle is from this elastic origin to the point where tightening was stopped in the elastic region.

2.3.3 Loosening Curve

When a fastener is loosened, a torque-angle loosening curve can be plotted which is a reverse of the tightening curve (refer back to Figure 15). This is also called a release angle audit or release angle method of tightness verification. A line is projected tangent to the elastic release portion of the curve and taken to zero torque, locating the elastic origin. The release angle, ascertained from the point where loosening starts to the projected elastic origin, is a direct measure of the tension released from the joint.

Experiments with strain gage bolts or force washers where the clamp force is measured along with the torque and angle during tightening will verify that this theory is correct for any given fastener. To apply torque-angle signature analysis, a torque-angle transient recorder is used for curve measurement and plotting. The transient recorder can provide curves on-screen for analysis as well as print them out for detailed study. Tightening, audit and release angle signatures for a given fastener can be simultaneously displayed and printed.

Figure 16 shows a release angle study performed on an automotive wheel nut. A tool with a torque and angle sensor connected to the transient recorder is used to loosen the nut, record the torque and angle values, and plot the data. The resulting printed curve shows a very high release torque. Applying the release angle method, a line is projected tangent to the elastic release portion of the curve to zero torque. This release angle, measured from the release torque point to the point where the tangent line crosses, is directly proportional to the tension or clamp force released.

Figure 16. Release Angle Study on Automotive Wheel Nut

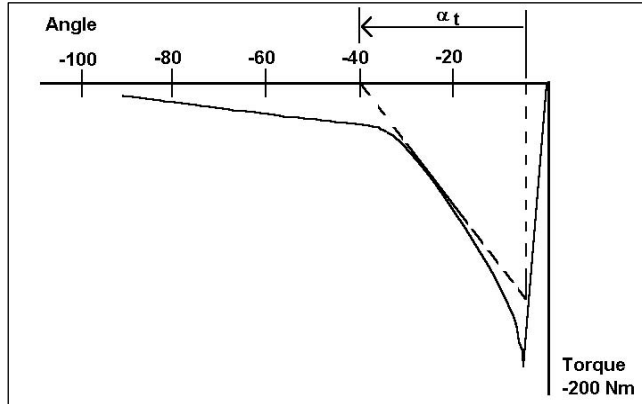

2.3.4 Beyond Yield

When a fastener is taken beyond the yield point, the torque angle signature method is used to find the elastic origin, project a line along the elastic curve above the yield point, then project the maximum torque level back to that line. The added tension after yield is the amount of angle relative to the straight line elastic clamping portion to that maximum torque point and is not proportional to the overall angle of turn as shown in Figure 17.

Figure 17. Determining Clamp Force Beyond Yield Point

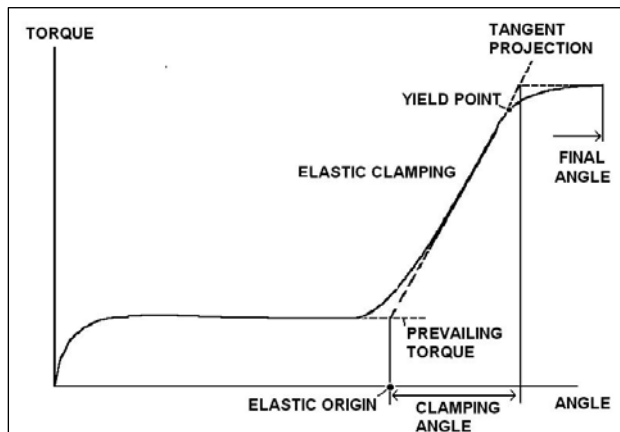

When performing a release angle audit on a fastener beyond yield, a similar projection of the elastic curve is done.

2.3.5 Loosening Tendencies

The release angle method has been successfully used to study fastener-loosening tendencies. In this application the torque-angle-tightening curve is first plotted, the elastic origin is located, and the amount of angle of turn from the elastic origin is determined. After the assembly has been allowed to relax, i.e. sit overnight or run on a hot test, the fastener is loosened and the loosening curve is studied. The release angle is determined, it is

compared to the tightening angle, and if not equal, evaluated to see how much tension was lost either by relaxation or loosening.

In one release angle study, a part had a tightening angle of 120 degrees. Once the part set overnight, the release angle was 20 degrees. The vendor already knew there was a major problem because the parts were falling apart. The study showed that there was relaxation in the threads that was causing approximately an 80 percent loss in clamp force over a 12-hour period. The release angle method provided a quantitative answer as to how much clamp force was being lost and clearly showed that a redesign of the parts was required.

The release angle method is also valuable for studying short grip length fasteners holding composite or plastic parts. Here, a torque-angle signature curve for tightening is produced, then the parts might be put in an environmental chamber and temperature cycled, followed by a release angle study. The release angle curve indicates the amount of clamp load loss due to embedment of the fastener into the plastic part under temperature. By changing joint geometry or by changing the size of washers, the effects can be quantitatively measured and compared.

2.3.6 Accurate Measurement

Torque-angle signature analysis is especially useful for studying critical fastener assemblies—critical in terms of safety or reliability—such as auto, truck, aerospace, and process industry applications, and the like. In the hands of a skilled operator, these studies can be accurate within 5 percent or better.

In addition to analyzing fastener problems such as loosening and embedment, torque-angle signature analysis can also be used to evaluate the performance of tightening tools in applying the desired clamp force on fasteners. It is particularly applicable for evaluating pulse tools and impact tools.

Pulse and impact tools move fasteners at high speeds with a great deal of stick-slip, chatter, and unique frictional characteristics that are not seen with steady, continuous tightening processes. These factors can lead to a deceptively high torque reading but with minimal clamp force created. By checking the assembled joint with a release angle study, the user can assure that an adequate angle of turn, and thus proper clamp force, is being achieved. Clearly this method of audit provides a direct measure of the capability of a given tool to develop tension in the tightened fastener. The results of release angle audits being directly related to the tension achieved are significantly more meaningful than the information gained from breakaway torque audits.

2.3.7 Torque-Angle Signature Analysis Summary

The torque-angle signature method of analysis is plain, simple, and straightforward. It is grounded in the basic physics of tightening a bolted joint. It can be applied to fasteners of all sizes, all grip lengths. While there may be 75-100 factors that affect the tightness of a given bolted joint, the torque-angle signature analysis method provides for direct verification of clamp force to assure a quality fastener assembly.

2.4 Clamp Force / Strength Considerations

The clamp force and preload requirements for a bolted joint are determined by the static and dynamic loads that the assembly is expected to see in service. The bolted joint design must be completely engineered with regard to the axial (concentric), eccentric, and side shear loads to which the assembly will be subjected. This is the first step in any fastener-engineering project.

After the external working loads have been defined, the necessary bolt preload can be calculated. Next, the safety factors against embedment and thread strip must be checked to insure that yielding in the bearing areas or threads will not limit the preload to less than the required amount.

The safety factors for embedment and thread-strip are important both for the initial installation of the fastener and for long term reliability with regard to both loosening and fatigue resistance. The illustration in Figure 18 shows some of the strength factors that should all be evaluated with regard to expected service loads and preload requirements.

Figure 18. Basic Geometric and Material Strength Factors

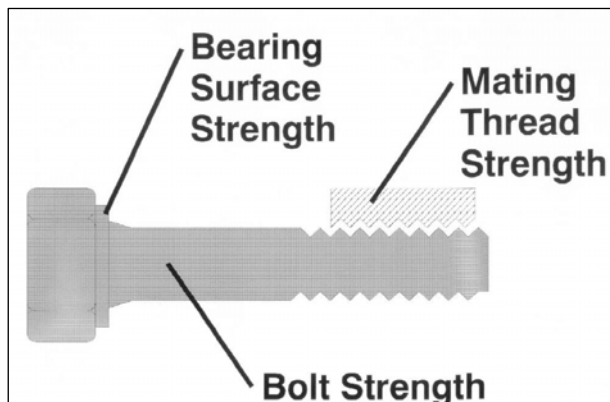

2.5 Modeling the Tightening Process

The process of tightening a fastener involves turning (advance of the lead screw) and torque (turning moment) so that preload (tension) is produced in the fastener. As discussed previously, the desired result is a clamping force to hold the components together. The most general model of the fastener tightening process has four distinct zones as illustrated in Figure 19.

Figure 19. Four Zones of the Tightening Process

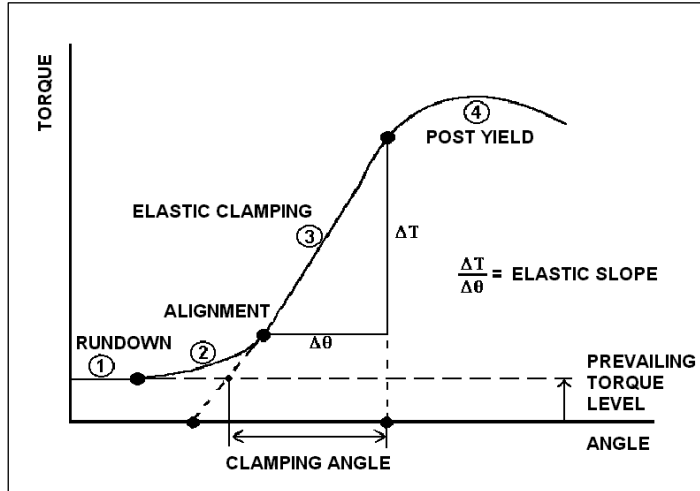

Zone 1 is the rundown or prevailing torque zone that occurs before the fastener or nut contacts the bearing surface. Prevailing torque due to thread locking features such as nylon inserts or deformed threads will show up in the rundown zone. Frictional drag on the shank or threads due to misalignment of parts, chips or foreign material in the threads as well as unintended interference due to out of tolerance threads are additional causes of prevailing torque in the rundown zone.

Zone 2 is the alignment or snugging zone, wherein the fastener and joint mating surfaces are drawn into alignment, or a stable, clamped condition. The nonlinear alignment zone is a complex function of the process of drawing together the mating parts, and bending of the fastener as a result of non-parallelism of the bearing surface to the fastener underhead surface. In addition to the macro effects related to alignment of parts, there are micro effects within the alignment zone. The micro effects include contact stress-induced deformations of plating and coatings as well as local surface roughness and thread deformations.

Zone 3 is the elastic clamping zone, wherein the slope of the torque-angle signature curve is constant. The elastic clamping zone torque-angle slope is a very important characteristic of each bolted joint. This slope can be projected backward to locate the elastic origin. Angle-of-turn from the elastic origin is multiplied by the angle-tension coefficient to calculate the tension that has been created by the tightening process.

The elastic origin is located at the intersection of the prevailing torque level and the backward projection of the elastic clamping zone³. To further illustrate the concept of the elastic origin, the torque-angle signatures in Figure 20 show the increased slope, induced by increased friction, in the elastic-tightening zone.

Figure 20. Friction Effects on Yield Point

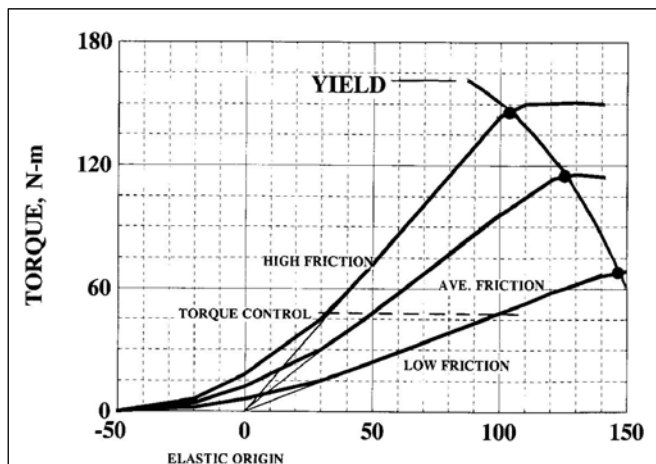

Note that as friction increases, the torque required to bring the bolt to yield is also increased. The curves in Figure 21 show that, as friction increases, the clamp force at the yield point is reduced, while the torque required to reach the yield point increases. This illustrates the fact that for a given fastener size, the torque required to yield the bolt is a function of the material yield strength and the thread friction coefficient.

³ A line drawn tangent to any point on the torque-angle curve, prior to the yield point, can be used to directly estimate the relative spring rate of the clamped assembly at that point.

Figure 21. Friction Effects on Applied Torque and Clamping Force

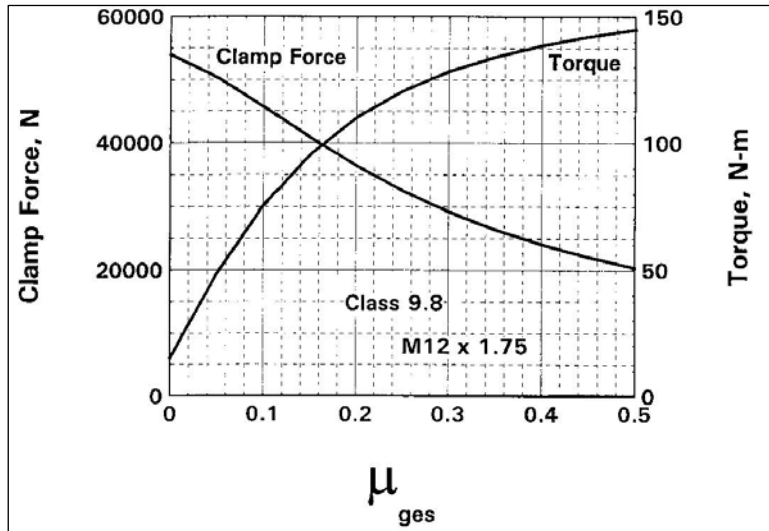

Once the torquing effort has been stopped in the elastic clamping zone, a line tangent to the straight-line portion of the curve can be projected backwards. The point where the projection line strikes zero torque, provided there is no prevailing torque, is called the elastic origin. If the angle-of-turn is measured from the elastic origin to the point where torquing was stopped in the elastic clamping zone, it has been found that the tension in the fastener is directly proportional to that angle-of-turn.

What is happening is that the compression of the parts and the stretching of the fastener is occurring

in a linear fashion from the projected elastic origin. Even if friction between threads or in the underhead region of the fastener is varied, it still will be found that within the elastic region, the tension generated is always proportional to the angle-of-turn from the elastic origin.

When studying a fastener where there is prevailing torque in the initial rundown, the line projected back along the elastic curve must stop at the prevailing level and the elastic origin will be set there rather than at zero torque. Then the tightening angle is from this elastic origin to the point where tightening was stopped in the elastic region.

Zone 4, as shown in Figure 19, is the post-yield zone, which begins with an inflection point at the end of the elastic clamping range. Yielding can occur in the bolt or in the joint assembly, as a result of underhead embedment or as thread strip in the bolt or mating threads. The yield point can be used to establish or verify the tension -angle coefficient for the torque-angle-tension tightening process.

2.6 Torque-Tension Coefficient: Nut Factor, K

The basic equation, $T = K D F$, can be applied to the linear elastic clamping zone of the assembly tightening process. The prevailing torque during initial rundown must be subtracted from the total applied torque, a procedure that is usually accurate for all practical purposes. If insufficient torque is applied to tighten beyond the alignment zone, the tension estimated for a given assembly will be still be correctly predicted if the overall K factor has been accurately estimated.

There are published tables of K factors for various combinations of materials, surface finishes, plating, coatings and lubricants. However, actual experience has shown that it is highly unreliable to assume that any given K value applies to a specific fastener being assembled. The importance of the torque-angle approach to assembly cannot be overemphasized when you are responsible for the safety and reliability of critical bolted assemblies. It is not uncommon to see variations in friction coefficients of 2:1 or more as the same fastener is repeatedly tightened and loosened. The most practical way to minimize the variation in clamp force for bolted assemblies is to use both torque and angle-of-turn in your assembly process.

The K factor, often referred to as the “nut factor,” can be expressed as a combination of three factors:

- K1 (a geometric factor, function of diameter, d and Pitch, P)
- K2 (a thread friction factor, function of μ_G and pitch diameter, d_2)
- K3 (a bearing friction factor, function of μ_K and D_{km})

The curve shown in Figure 22 illustrates the value of the nut factor K, as a function of the average friction coefficient. The underhead friction coefficient, μ_K , and the thread friction coefficient, μ_G , are assumed to be equal to μ_{ges} for this example.

Figure 22. Nut Factor, K, as Function of Friction

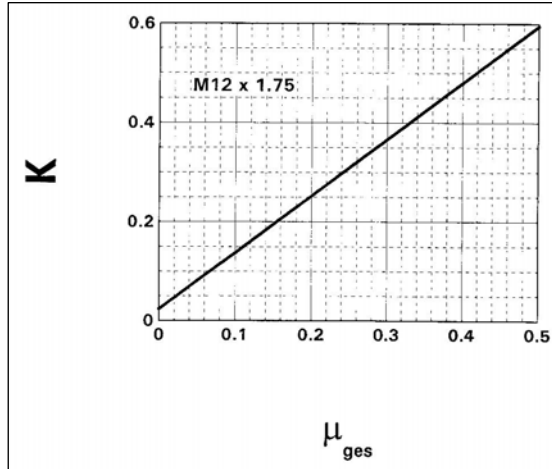

2.7 Experimental Determination of Friction Coefficients

Tabulated values of K are not reliable for applications with any assurance of predictable results for a given bolt or nut assembly. It is equally true that friction coefficients determined experimentally must be used for comparison purposes and supplemented by torque-angle assembly monitoring to assure proper assembly clamp forces.

The German norm, DIN 946⁴, provides a practical standard method for evaluation of friction coefficients on screw threads and underhead bearing surfaces. Fastener laboratory testing machines are available for determination of friction coefficients according to DIN 946.

A Fastener Laboratory Test Machine for testing fasteners up to M36 size is shown in the photograph, Figure 22. The largest existing machines of this type are capable of testing fasteners up to M100 with clamp load capacities up to 500 kN and torque capacities of 35 kNm. Small table top units are available for testing fasteners in the sizes below M1 (English fasteners down to 0-80).

Figure 23. Laboratory Fastener Test Machine, Typical

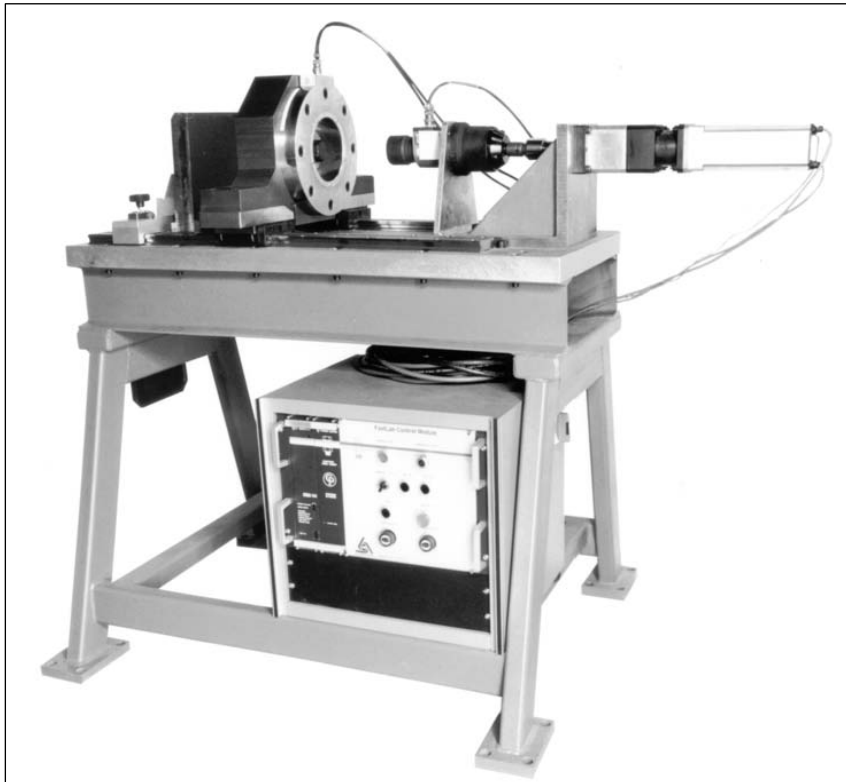

2.8 Thread / Underhead Friction Coefficient Measurements

In the development of threaded fastener materials, surface finishes, plating, coatings, and thread locking adhesives, it is necessary to measure and control the friction coefficients on both the threads and underhead regions of the fasteners.

A Torque-Tension Research Head, as illustrated in Figure 24, is a special load cell constructed to simultaneously measure both thread torque (pitch torque plus thread friction torque) in addition to the tension created as the tightening torque is applied. Special devices such as locknuts, serrated underheads, and thread locking adhesives

and friction patches can be tested and friction performance standards can be established and maintained through measurements made with the Torque-Tension Research Heads. The Research Head has the capability to fully test for friction coefficients according to DIN 946.

⁴ DIN 946, Determination of coefficient of friction of bolt/nut assemblies under specified conditions (October 1991)

Figure 24. Torque-Tension Research Head

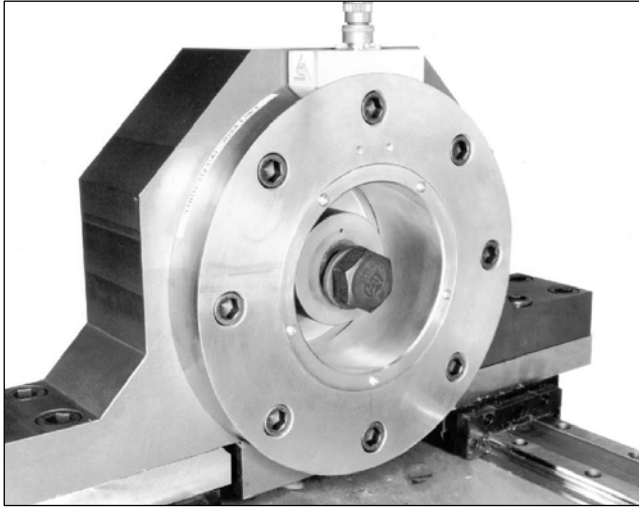

The average coefficient of friction, μ_{ges} , can be roughly estimated by measuring the change in length of a screw or bolt after application of a given tightening torque. This method can only be applied if there is no yield occurring in the bolt, threads or elsewhere in the joint.

2.9 M-Alpha Diagram

The M-Alpha (torque angle) Diagram, Figure 25, is the straight-line projection of the tangent to the torque-angle assembly curve as projected backwards from the final elastic tightening point to zero torque, or the prevailing torque level. This tangent projection is used to locate the elastic origin. Within the elastic tightening zone of the assembly process the clamp force developed is directly proportional to the angle-of-turn from the elastic origin.

Figure 25. M-Alpha Diagram

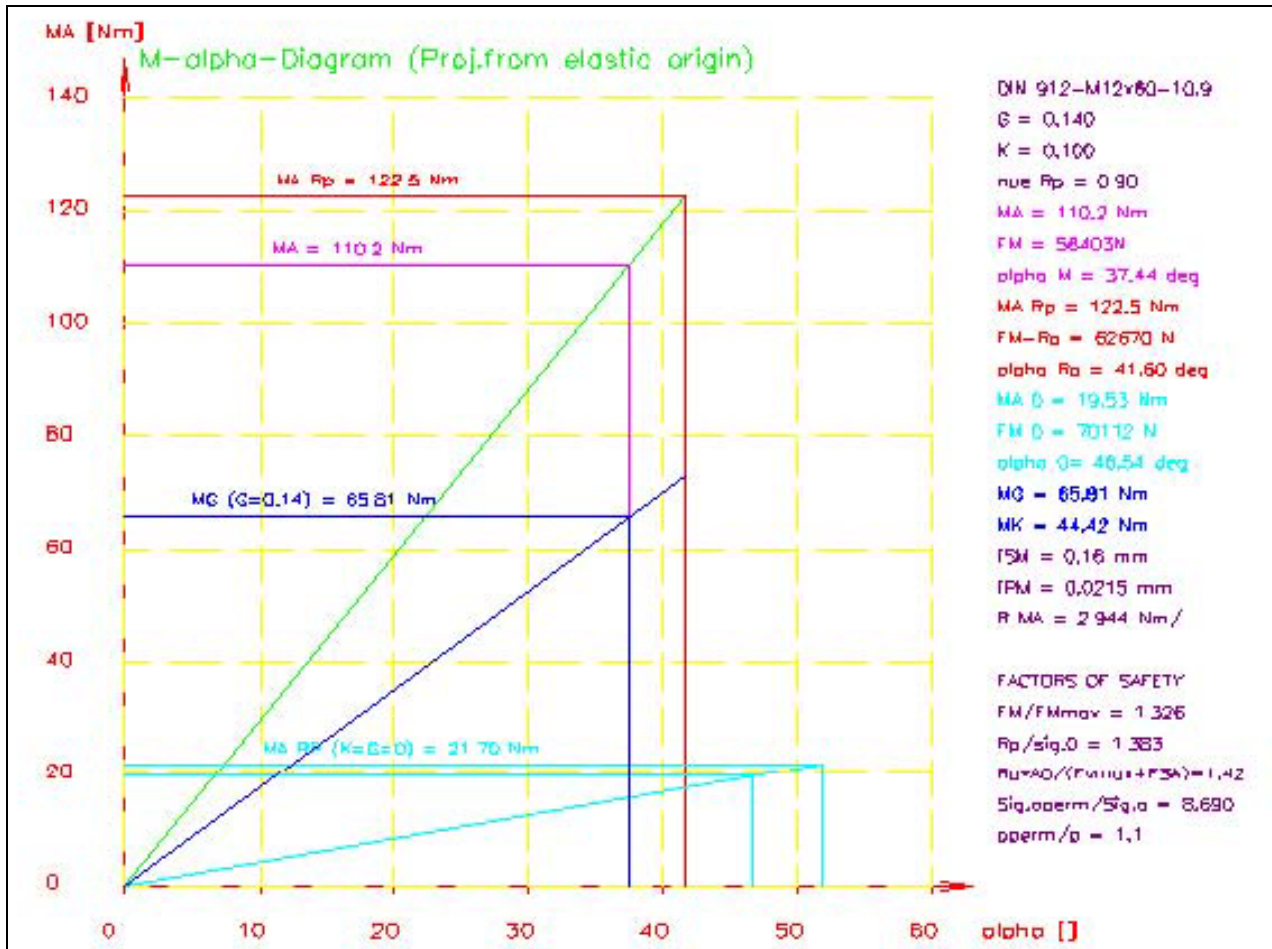

Since the M-Alpha Diagram was first developed as an extension of the SR1, VDI 2230 Bolted Joint Design Software, we have chosen to retain the terminology of the VDI standard glossary of terms (i.e., M for torque, from the German Drehmoment). These terms are defined in Section 8.0. Thus, we have

torque-angle measurements from testing corresponding to the M-Alpha Diagram calculated as part of the SR1 VDI 2230 design software.

In addition to the applied torque MA, the M-Alpha Diagram has projections from the elastic origin for both the thread torque MG, and the pitch torque MA_{RP} (where μ=0). A very useful feature of the M-Alpha Diagram is the easy manner in which the diagram clearly illustrates the distribution of the torque in a tightening process. With MA showing the total input torque, MG represents the thread torque that is the thread friction plus the pitch torque that creates the clamp-force. The difference between the MA and MG curves represents the underhead friction torque. The difference between the pitch torque curve and the MG curve represents the thread friction torque.

The SR1 M-Alpha Diagram is a straight line projected from the elastic origin to the yield point. By changing the thread friction (μ_G) and underhead friction (μ_K) coefficients assumed for the VDI 2230 analysis, the effect of friction on the tightening process can be clearly seen on the M-Alpha Diagram.

2.10 FM-Alpha Diagram

The FM-Alpha (clamp force-angle) diagram, Figure 26, is a new feature that was added to the SR1-VDI 2230 design software. This diagram illustrates the clamp force vs. angle-of-turn from the elastic origin. The slope of this curve in Newtons/degree establishes the angle-tension coefficient for a specific bolted joint design.

Figure 26. FM-Alpha Diagram

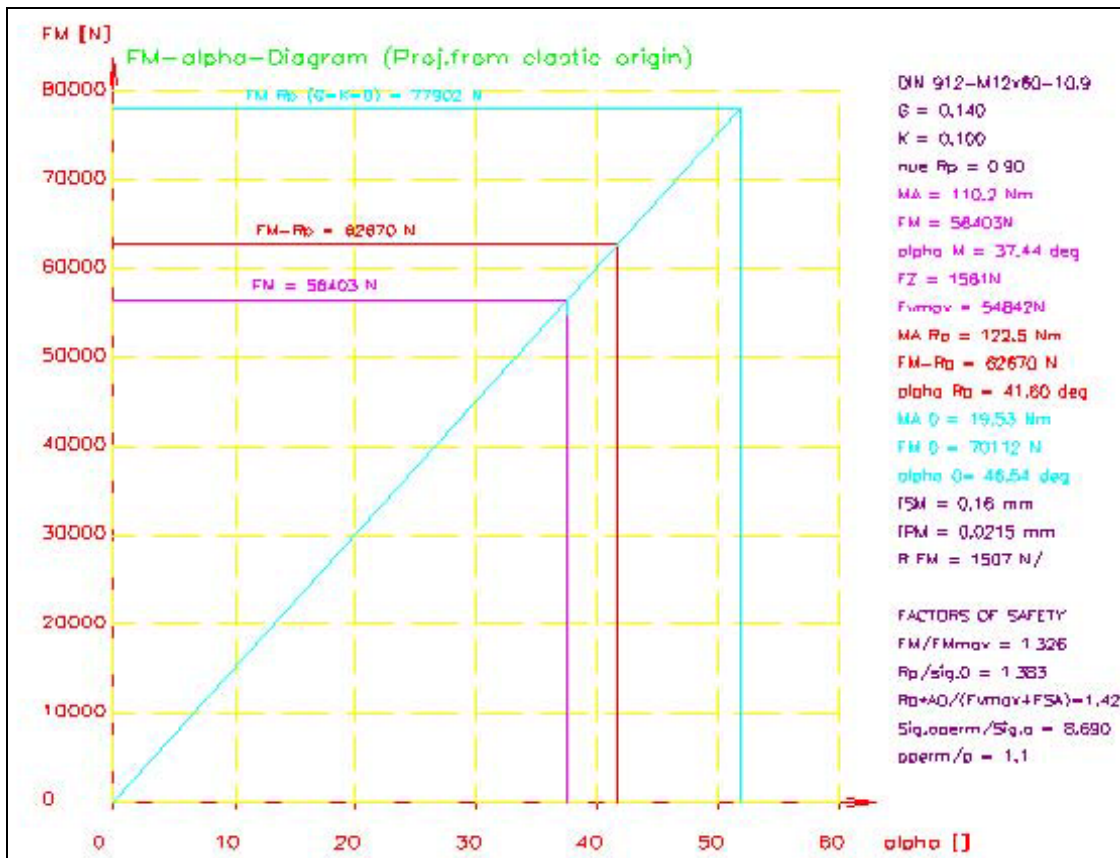

The upper limit of the elastic clamping range is the yield point, which is calculated based upon the specified thread friction coefficient (μ_G) and the material tensile yield strength, i.e., M10.9, 940 Mpa. The maximum shear strength Mohr Circle calculation is used to determine the combined tension-torsional yield load.

2.11 Estimating the Tension-Angle Coefficient

The angle-tension coefficient can be estimated by several methods, each of which can be used to confirm the estimate made by one of the others. Basic guidelines for these methods are given in the following sections. □ Ultrasonic Stretch (para 2.11.1)

- Strain Gaged Bolt (para 2.11.2)
- Force Washer (para 2.11.3)
- Model-Calculation (para 2.11.4)
- Material Property - Yield (para 2.11.5)

2.11.1 Ultrasonic Stretch

The Ultrasonic Stretch method starts with ultrasonic stretch or tension calibration of the test bolt. After the bolt is calibrated, it is installed in the assembly and the torque-angle signature is recorded. The ultrasonic measurement is then made to determine the stretch or tension developed by the installation torque. Provided that the fastener was not stressed beyond the yield point, and that no yield was induced in the threads or underhead, the tension reading can be used to calculate the tension-angle coefficient.

The elastic origin is located on the torque-angle signature curve recorded when the fastener was tightened. The clamp force measured by the ultrasonic stretch measurement is divided by the angle of turn from the elastic origin to determine the slope of the FM-Alpha curve. Once this information is available, it is possible to confirm the original bolted joint design with detailed FEA calculations, or through use of the SR1 design software.

2.11.2 Strain-Gaged Bolt

The Strain-Gaged Bolt method of determination of the tension-angle coefficient starts with calibration of the bolt prior to installation in the assembly. The calibrated bolt is tightened in the assembly and the torque-angle signature is recorded. Provided that only elastic tightening has occurred, i.e., no yield is detected, the tension reading from the test bolt can be used to determine the tension-angle coefficient.

The torque-angle signature is evaluated to locate the elastic origin. The elastic-tightening angle from the elastic origin to the final tightening torque is divided into the measure clamp load to determine the tension-angle coefficient.

If a two channel transient recorder, such as the RS Technologies Model 960 shown in Figure 27, is used to record the torque-angle signature you should be able to directly plot torque-tension, torque-angle and force-angle curves. M-Alpha and FM-Alpha curves are standard plots generated by the Model 960 based on the recorded torque-angle signatures.

Figure 27. Two-Channel Transient Recorder



The use of a strain gaged bolt will result in a modification of the bolt stiffness unless the bolt is dimensionally the same as the un-gaged bolt. Calculation of the tension-angle coefficient should take into account any estimated change in stiffness for the bolt from the fasteners to be assembled in the normal assembly process.

The friction coefficients for the thread and underhead regions of the fastener will most likely not duplicate the conditions on the normal production parts. This should be recognized as not a major problem as long as we are focusing on obtaining the tension-angle coefficient. If we were trying to obtain a “torque-tension” coefficient the futility of the effort should be obvious to anyone familiar with how fastener friction affects torque-tension.

2.11.3 Force Washer

The use of a calibrated Force Washer to determine the tension-angle coefficient for a bolted joint requires some extra calculation to estimate the effect of the increased bolt length and the spring rate of the force washer in parallel with the clamped parts.

The increase in angle of turn due to the longer bolt and softer joint when using a force washer means that the actual tension-angle coefficient will be larger than when tightening the assemblies with no force washer present in the joint.

The torque-angle signature as well as the torque-tension curves can be recorded. The tension vs. angle curves and FM-Alpha curves can be directly plotted from the transient recorder. Using the SR1 design software the increased length of the bolt and the stiffness of the force washer can be introduced into the design calculation model.

By adjusting the shape and stiffness of the clamped elements in the SR1 design software, the slope of the calculated FM-Alpha plot can be matched to the actual measured curve as plotted by the transient recorder. Since clamp load is proportional to angle of turn from the elastic origin, calculations for the FM-Alpha Diagram are independent of the friction coefficients up to the bolt yield point.

Once we have refined the joint model with the force washer in-place so that the model matches the measured FM-Alpha curve, we can shorten the bolt and remove the force washer element from the model. The final model will now allow us to directly calculate the tension-angle coefficient. The resulting M-Alpha Diagram will now show the effect of friction coefficient variations on the slope of the elastic-tightening region of the torque-angle signature. The effect of thread friction on the yield load can also be demonstrated.

Of course, once the bolted joint is fully modeled by combination of experimental and theoretical calculations the SR1 design software automatically calculates all of the safety factors according to the VDI 2230 guide.

2.11.4 Model-Calculation: Estimate of Angle-Tension Coefficient

The Model-Calculation method in its simplest form involves selecting a value for the nut factor, K, which is used to calculate an initial estimate of the clamp force expected for a given torque. While it is acceptable to simply pick a value for K to be used in preliminary calculations, a more precise model can be developed if coefficients are estimated for thread and underhead friction, and K is calculated based upon these assumptions. The formula for calculation of K is illustrated as follows.

$$K = K_1 + K_2 + K_3$$

Where:

K_1 = the geometric function of diameter d and thread pitch P

K_2 = the thread friction factor, a function of the thread friction coefficient μ_G , and the pitch diameter d_2

K_3 = a bearing friction factor, a function of the underhead friction coefficient μ_K , and the mean bearing or underhead diameter D_{km}).

Using an effective length of the bolt equal to the grip length plus one diameter, the bolt stretch due to the estimated clamp force is calculated. For a given thread pitch, the angle-of-turn required to provide the desired stretch is calculated.

The torque-angle signature is obtained while tightening to the specified torque. After locating the elastic origin on the signature plot, it is possible to determine the total tightening angle, which includes bolt stretch and compression of the clamped parts.

The angle-tension coefficient is estimated as the clamp force derived from the basic $T = K D F$ formula using the assumed value of K , with the angle of turn from the elastic origin obtained from the test signature curve.

From this information it is possible to make a preliminary estimate of the relative stiffness of the clamped parts compared to the bolt. The stretch of the bolt is translated to terms of angular rotation based upon the simple relationship between the stretch due to the estimated load and the pitch, P of the thread.

Using FEA⁵ it is also possible to model the bolt and joint spring rates so that an estimate of the angle-tension coefficient can be made. Since this method involves estimating a proper K value one or more of the other methods must always back it up. A combination of torque signature analysis with the SR1 design software is perhaps the most efficient way to calculate the joint and bolt spring rates necessary for a complete bolted joint analysis.

2.11.5 Laboratory Measurement of Friction Coefficients

A Torque-Tension Research Head, as shown in Figure 28, is used to make the measurements necessary to determine the friction coefficients for the under-head and thread regions.

Figure 28. Torque-Tension Research Head

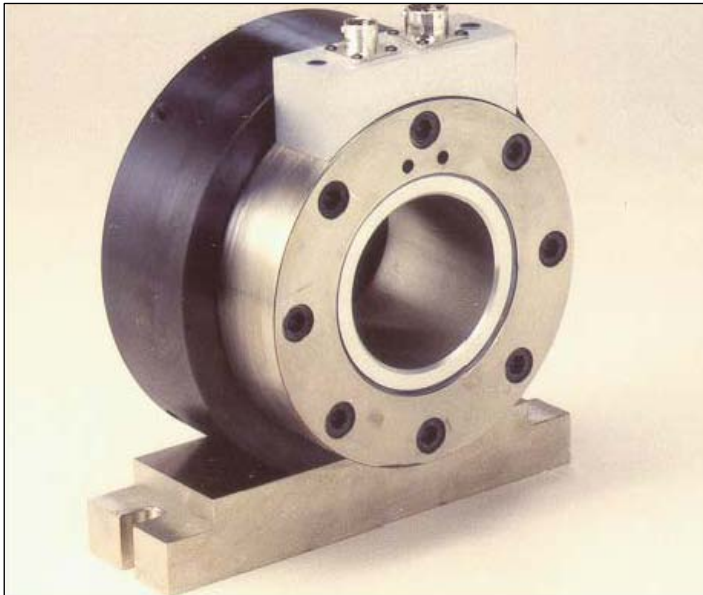

The equations for this analysis are directly derived from the force-torque free-body diagrams for the 60-degree Sellers thread form. Mechanical engineering design textbooks, such as those by Robert C. Juvinall and Joseph Shigley, provide a detailed derivation of the torque-tension relationships for threaded fasteners. The equations presented in the German Standard DIN 946 can be verified following the derivations presented by Juvinall and Shigley. Using the terminology of DIN 946, which also corresponds directly with the terminology of VDI 2230, it is possible to calculate the nut factor, K , based upon the friction coefficients, bolt pitch diameter and thread pitch. The formula for calculation of the nut factor, K , is based on the simplified torque-tension equation $T = K d F$ as follows:

$$K = \frac{0.159P + 0.578d_2 \mu_G + \left(\frac{D_{KM}}{2}\right) \mu_K}{d}$$

Where:

P = the thread pitch

d_2 = the pitch diameter

μ_G = the thread friction coefficient

D_{KM} = the mean bearing diameter or underhead

μ_K = the underhead friction coefficient d = the nominal diameter of the bolt

⁵ FEA, Finite element analysis modeling methods.

With properly designed test fixtures, the Research Head⁶ is used to test a variety of fastener configurations, i.e., 1) tightening the bolt, 2) tightening the nut, 3) tightening self tapping screws, and 4) tightening pipe thread fittings. For example, when conducting tests according to ANJ-514 for high pressure pipe fittings, the use of special tooling permitted a 1/4-inch grip length to produce significant information that was used to compare Cadmium plating with various Zinc formulations.

2.11.6 Material Property –Yield

When a fastener is taken beyond the yield point, the torque angle signature method is first used to find the elastic origin. Then the yield point is located at the upper end of the elastic tightening curve where the linear portion of the signature rolls over into the post yield tightening zone.

The added tension after yield is the amount of angle relative to the straight line elastic clamping portion to that maximum torque point and is not proportional to the overall angle-of-turn (refer to Figure 29). First, project a line along the elastic curve above the yield point. Then project the maximum torque level back to that line.

Figure 29. Determining Clamp Force beyond the Yield Point

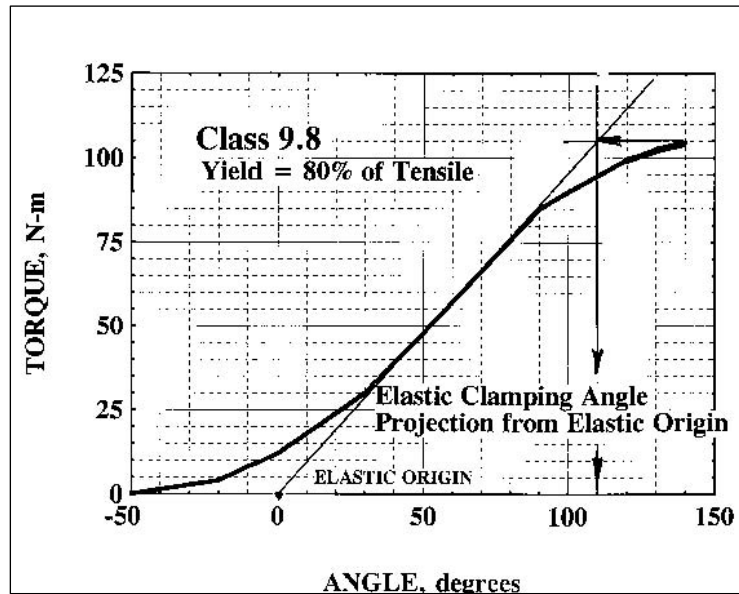

This procedure only works properly if the observed yield point is due to the bolt yielding. Joints where thread strip or underhead embedment occurs before bolt yield cannot be evaluated by this method.

It is generally true that once threads strip or embedment starts, the clamping load no longer increases at the same rate relative to angular turn. In most cases, particularly in response to thread stripping, the clamp load does not increase at all although the torque may increase 25-35 percent after the onset of yielding. Failure to properly recognize this phenomenon has been the downfall of a number of attempts to utilize “yield sensing” tightening strategies.

The clamp load at the bolt yield torque is primarily a function of the material properties of the bolt, and the thread friction coefficient, μ_G .

Underhead embedment resulting from compressive yield in the bearing area depends upon the strength of the bolt or nut relative to the clamped surface strength.

Thread yield, or thread strip, is a function of the length of thread engagement and the relative strengths of the bolt and mating thread materials.

Refer to Figure 30 for an illustration of the characteristic “yield signature” curves for both bolt yield and thread strip/embedment. Note that for bolt yield the maximum increase in torque after the yield point is only 10-20 percent due to the typical ratio between yield and tensile strengths for commonly used bolt materials, i.e., for a metric class 10.9 bolt the difference is 10 percent.

⁶ RS Technologies Torque-Tension Research Head with capacities of 1000 KN (225,000 lb.) and 4000 Nm (3,000 lb-ft)

Figure 30. Yield Signature Curves

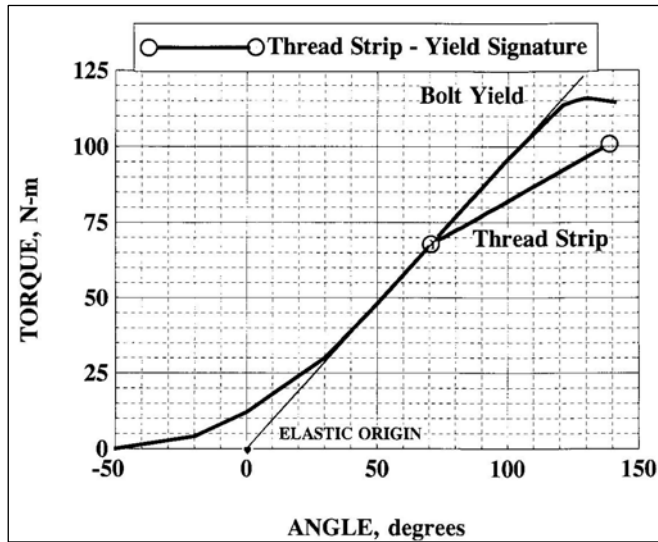

Also illustrated is the torque-angle signature beyond the yield point for a tightening process where thread strip or underhead embedment has occurred. Torque increases of 25-35 percent or more after the underhead yield or thread strip point are often observed. The difference between the two types of yield phenomena is usually very clear. However, this again can be used as a reminder to try to calculate the relative safety factors for bolt yield, thread strip and underhead embedment.

When a bolt is torqued to the yield point the yield clamp load is always less than the simple tension-test yield load. This is due to the combined tensile and torsional stresses on the shank of the bolt resulting from the torquing process.

Figure 21, presented previously, illustrates the effect of thread friction on the torque and clamp force at the yield point.

With the torque-angle signature it is possible to measure the elastic-tightening angle from the elastic origin to the yield point. If a nominal friction coefficient of 0.1 is assumed for the thread and underhead then the clamp load at the bolt yield torque will be about 80 percent of the tensile-test yield load.

The tension-to-angle coefficient is then calculated as the yield clamp load divided by the angle of turn from the elastic origin to the yield point. The tension-to-angle coefficient is the slope of the FM-Alpha Diagram created by the SR1 design software.

If thread strip or underhead embedment occurs before bolt yield it is necessary to estimate the load at this yield point and divide the load by the elastic tightening angle to the tension-angle coefficient.

It is sometimes possible or necessary to cold work a bearing surface by repeated tightening beyond the yield point so that adequate clamp force can be achieved on the bolt. However, it is poor practice to design bolted joints where thread strip or embedment occur before the bolt yields.

2.12 Torque-Angle Tension Control Summary

The proper application of any assembly process includes the requirement that limitations and safety factors associated with the specified procedures be understood and well documented. This philosophy is in accordance with the principles defined by ISO 9000 and QS-9000 documentation requirements that have become the guiding quality operating system methods for manufacturing worldwide.

A relatively simple two-step process of torque-angle tightening was defined at the beginning of this section with a few short sentences. It should now be clear to the reader who has taken the time to go into the details which followed the introduction that this “simple” assembly procedure is potentially far more complicated than it initially appears to be.

The benefits gained through understanding how fasteners really work can be enormous. In terms of cost both material and in human life and suffering, the results of poor bolted joint design and failed assembly procedures have been reported at many millions of dollars per year.

For a total engineering approach to assembly an understanding of the principles of mechanics and material science underlying the performance of threaded fasteners is essential. The effects of thread

friction, underhead friction, bearing areas, material strengths, thread strength, joint strength, must all be accounted for when a tightening process is specified.

In the final analysis, only actual experience from the field will tell if the design of an assembly is successful. However, with a proper understanding of the assembly process through torque-angle signature analysis, significant insight into the assembly process and potential reliability of any bolted joint can be developed.

3.0 Torque – Tension Audits

The following paragraphs discuss the principles of conducting torque tension audits.

3.1 Introduction

The art of auditing torque on tightened fasteners has changed significantly during the past three decades. Prior to 1968, the primary method used to audit fasteners attempted to observe the “breakaway torque” as a previously tightened fastener was advanced in the tightening direction. Typically, the torque reading was obtained with a bending beam or dial indicator-type torque wrench. While this technique is still used today for non-critical applications, the readings obtained are known to have little or no correlation with the actual tension developed by the installation torque.

Other than the fact that, in general, higher values of breakaway torque indicate that higher installation torque may have been applied, the breakaway torque measurement can not be relied upon to verify fastener tension.

Following the introduction of the first rotary socket wrench torque transducers and the first battery powered portable peak meters in 1968, there has been continuous development of fastener torque measurement technology. The comparison of dynamic-applied torque to hand torque audits was only possible after the first rotary socket wrench torque sensors were introduced with suitable peak torque reading instruments.⁷ The techniques for measurement and interpretation of torque signatures have become highly refined and capabilities have been developed to interpret both tool torque control as well as make other more meaningful measurements which can be correlated with actual fastener tension. \

If the friction coefficients and other variables associated with a given bolted joint are uniform and repeatable it is possible to demonstrate that fastener assemblies tightened to a specified torque will achieve clamp loads with sufficiently low scatter for reliable performance of the assembly. Tightening to a specified torque is still the most widely used assembly process.

Torque-turn tightening strategies add a significant degree of precision to the capability to achieve a specified initial pre-load. They are clearly needed for applications where personal injury or loss of life or other costly consequences is likely if loosening or fatigue failure should occur.

Use of torque as the sole means of achieving fastener initial preload always indicates that the person responsible for the specification has accepted the scatter in preload results which naturally will occur. It should also be recognized that torque tightening strategies are based upon statistical variations of a known degree of scatter, and there is no provision to allow for problems introduced when parts with characteristics outside of the normal population show up on the assembly line.

Torque only tightening strategies assume that the materials have known torque-tension characteristics with a sufficiently small six-sigma scatter so that desired pre-load will be achieved if the proper, specified torque is applied. Hand torque audits are used to verify the installation torque. Torque-angle signature analysis methods can now be used to audit the installation torque, and with some additional study can be used to audit actual tension on tightened fasteners.

⁷ Historical Note: The first commercially available socket wrench torque transducers and battery-powered peak meters were designed and developed by Macit Gurol and Ralph Shoberg, co-founders of GSE, Inc.

Dynamic torque measurements and tool certification audits following guidelines such as ISO-5393 are used to verify the capability of tools to consistently apply the specified torque over a broad range of joint friction and spring rate conditions.

Fastener engineers and mechanical designers have much to learn from the art of "torque-turn signature analysis". Experienced practitioners of the art of fastener signature analysis are capable of stripping away much of the mystery and uncertainty which often is associated with the strength and reliability of threaded fasteners and bolted joints.

3.2 Hand Torque Audit-Tool Torque Capability

Hand torque audits are used to verify the amount of torque that has been applied to a fastener. Torque audits are not capable of predicting fastener tension accurately. Measurement of applied torque alone does not provide sufficient information to permit estimation of clamp load achieved.

It is a fundamental rule of analysis that if more than one variable can significantly affect a result then more than one measurement must be made to independently verify the desired result.

3.3 Tool Torque Capability / ISO 5393

The primary focus of ISO 5393 is to provide a standard method for evaluation of the capability of assembly tools to tighten fasteners to a specified torque. The performance of a tool is first checked on "soft" joints where the angle of turn from 10 percent of the maximum torque to maximum torque is greater than 360 degrees. Next the ability of the tool to deliver controlled torque on "hard" joints where the tightening angle is 30 degrees is compared to the soft joint values to establish a tool torque control capability index.

A complete laboratory for testing of tool torque capability has been established by Ford Motor Company at Lawrence Technological University in Southfield, Michigan.

3.4 Release Angle-Tension Audit

The tension or clamp force developed and not applied torque determines whether the fastener has been properly tightened. Since variations in friction coefficients can produce as much as 3:1 or greater variation in clamp force it is necessary that some method other than monitoring applied torque be used to confirm the performance of tools in achieving fastener "tightness."

This is particularly important in the special case of pulse or impact tools where the fastener is tightened with a series of torque impulses. The short duration pulses transfer energy into the bolted joint in a discontinuous process which can be greatly influenced by both the joint spring rate and the frictional characteristics of the fastener thread and underhead bearing surface.

Since it is possible to demonstrate "breakaway torque" correlation between "dynamic torque" applied by hand or electric/pneumatic tools with a continuous energy transfer process many individuals have attempted to use the same process to audit fasteners tightened with pulse and impact tools. Due to the physics of the energy transfer process and the variable frictional characteristics and joint energy input requirements which tools must respond to (i.e., ISO 5393) it should be clear that such efforts are doomed to failure.

Those who have tried to accomplish this task have experienced great frustration. Not understanding the nature of the problem, joint specific "fixes" have been tried. Reducing the frequency response (filtering) of the dynamic measuring instruments to force the dynamic readings to be closer to the static breakaway readings is the only way to obtain such correlation. For a given pulse or impact tool the method immediately fails as soon as the tool is applied to a fastener where the joint rate vs. friction characteristics vary from the initial setup conditions.

If the peak torque pulses are read with very high frequency response instruments the peak torque readings can be used to verify the setup of the pulse tool. For such tests to be meaningful the joint spring

rate and friction coefficients must be controlled or standardized. At the present time no standard, ISO or otherwise, exists as a guide to define the test joints for qualification of pulse or impact type tools. Thus the individual user must develop his own standards to meet his specific tool testing requirements.

In the final analysis, the actual tension and preload developed by the tightening process is the result that must be verified.

Examining the torque-angle signature of a fastener basically means looking at tightening and loosening curves or plots of torque versus angle as the fastener is first installed and then loosened. These curves are studied initially in the elastic-tightening region where the fastener has not gone beyond yield, as shown in Figure 31.

Figure 31. Torque-Angle Signature with Embedment

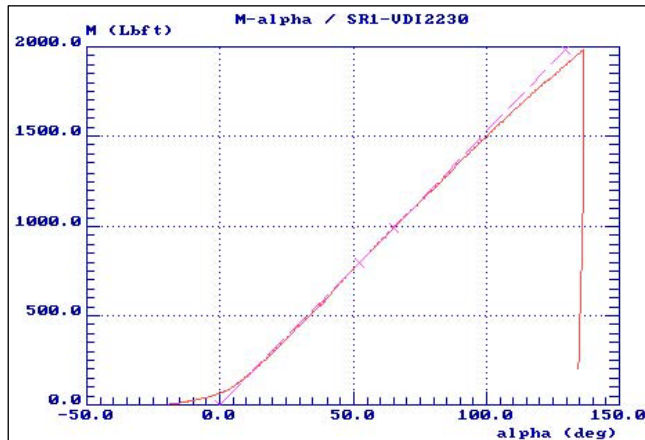

Analysis of this signature provides a direct method for verification of preload or tightness. A line tangent to the elastic release portion of the curve projected to zero torque locates the elastic origin. The release angle, measured from the point where loosening starts to the projected elastic origin, is a direct measure of the tension released from the bolted joint.

When a fastener is loosened, a torque-angle-loosening signature, as shown in Figure 32, can be recorded. The release signature shows the "release" of the fastener stretch and also the release of the compression in the clamped parts.

Figure 32. Loosening Torque-Angle Signature

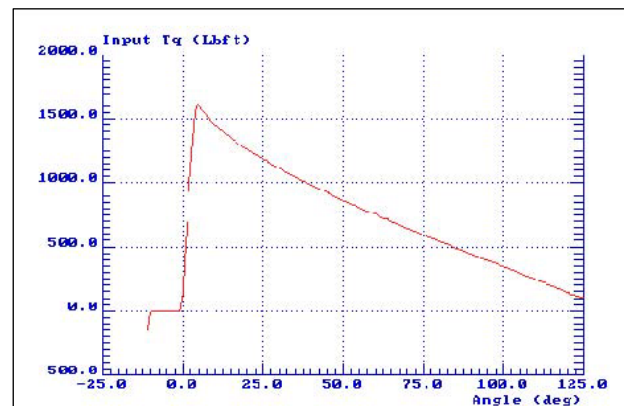

The tangent line must be drawn on the straight-line portion of the curve after the initial peak release torque due to static friction or thread-locking adhesive has been broken free. The starting point is the angle where initial loosening motion begins. The total release angle is measured from the initial loosening point to the projected elastic origin. (Note: If a significant prevailing torque is present after loosening the fastener, the elastic origin must be located at the prevailing level, not zero torque.)

The torque-angle signature shown in Figure 1 has been plotted as an M-Alpha Diagram (i.e., torque-angle) with the tangent line, locating the elastic origin, drawn at 50 percent of the maximum torque to set the elastic tightening slope below the onset of embedment of the nut. The bolt is a M30 x 3.5 with a strength Class 11.9.

The clamp force signature, plotted on the F-Alpha (i.e., preload-angle) Diagram confirms that the clamp force increases linearly with the angle of turn from the projected elastic origin. In the example shown in Figure 33, the elastic-tightening angle is approximately 125 degrees.

Figure 33. Clamp Force vs. Angle of Turn from Elastic Origin

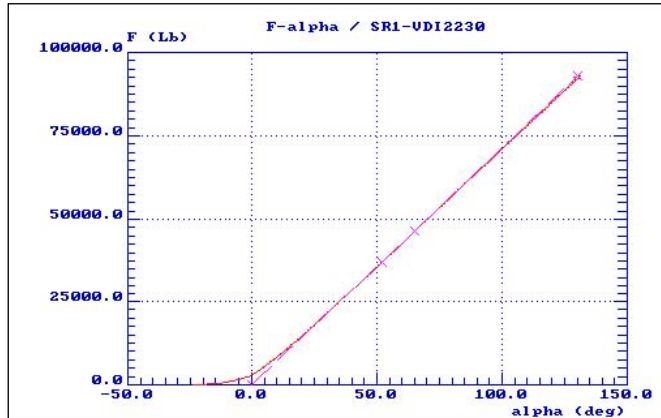

The loosening torque-angle signature (refer to Figure 32) has a projected re-release angle of approximately 125 degrees. The F-Alpha Diagram (refer to Figure 33) confirms the fact that even after embedment occurs the clamp force increases directly in proportion to the angle of turn from the elastic origin.

Experiments with strain gage bolts or force washers, where the clamp force is measured along with the torque and angle during tightening, will verify that this theory is correct for any given fastener.

To apply torque-angle signature analysis, a torque-angle transient recorder is used for curve measurement and plotting. The transient recorder can provide curves on-screen for analysis as well as print them out for detailed study. Tightening, audit and release angle signatures for a given fastener can be simultaneously displayed and printed.

Figure 34 shows a release angle study performed on an automotive wheel nut. A tool with a torque and angle sensor connected to the transient recorder is used to loosen the nut, record the torque and angle values, and plot the data. The resulting printed curve shows an extremely high release torque. The high initial breakaway loosening peak torque region is disregarded, as this is simply an indication of the static torque required to start loosening motion.⁸

Figure 34. Wheel Nut Loosening Signature

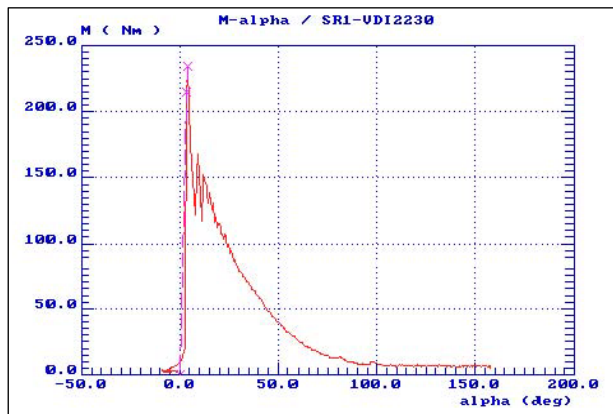

The elastic release angle for the wheel nut shown above is approximately 40 degrees. The nut had been tightened to a peak torque of 206 Nm (152 lb-ft), which is 75 Nm (55 lb-ft) greater than the vehicle manufacturer specification. The wheel nut was originally tightened to a torque of 160 Nm (118 lb-ft), which did not appear to get past the tightening alignment zone as shown by the signature shown in Figure 35.

Figure 35. Wheel Nut Installation Signature

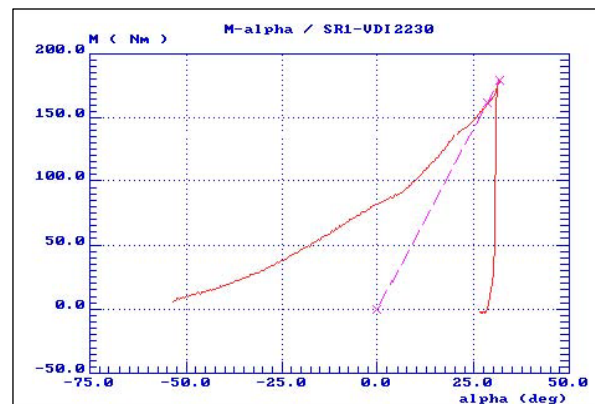

The installation was followed by a hand torque breakaway audit where the nut was advanced about 7-8 degrees in the tightening direction as shown in Figure 36. The M-Alpha Diagram for the audit shows that the final torque was about 206 Nm (152 lb-ft), with a projected elastic-tightening angle of 40 degrees.

⁸ The **high value of release torque** is significant from the point of view that it illustrates the high thread friction due to **thread pitch distortion** on the wheel nut, a factor that helps prevent vibratory loosening on typical wheel nuts.

Figure 36. Wheel Nut Torque Audit Signature

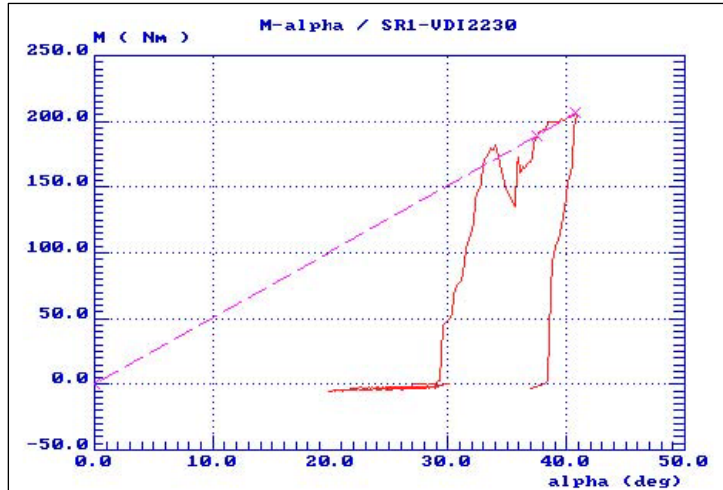

Applying the release angle method, a line is projected tangent to the elastic release portion of the curve to zero torque. This release angle, measured from the release torque point to the point where the tangent line crosses the zero torque or prevailing torque level, is directly proportional to the tension or clamp force released. Comparing Figure 6 with Figure 4 a significant correlation is seen to exist between the release angle determined by loosening the fastener and the M-Alpha Diagram as applied to the Torque-angle signature for the breakaway audit. The loosening signature in Figure 34 was recorded after the audit plotted in Figure 36.

3.5 Loosening - Embedment or Loss of Preload

The release angle method has been successfully used to study fastener-loosening problems. The basic procedure involves recording and analysis of the torque-angle signatures for tightening and then loosening the fasteners that are to be tested.

First the torque-angle-tightening curve is plotted, the elastic origin is located, and the amount of angle of turn from the elastic origin is determined. After the assembly has been allowed to relax, for example, to sit overnight or run on a dynamic field test, the fastener is loosened and the loosening curve is analyzed. The release angle is determined, compared to the tightening angle, and if not equal, evaluated to see how much tension was lost by relaxation or loosening.

In one release angle study, a fastener had a tightening angle of 120 degrees. Once the part sat overnight, the release angle was 20 degrees. The manufacturer was already aware there was a major problem because the parts were literally falling apart somewhere between the assembly factory and the auto plant where they were delivered for final assembly in vehicles. The signature analysis study showed that creep or relaxation in the threads was causing an approximately 80 percent loss in clamp force over a 12-hour period. The release angle method provided a quantitative answer as to the amount of clamp force lost, and clearly showed that the parts needed to be redesigned.

The release angle method is particularly valuable for studying short grip length fasteners holding composite or plastic parts. These parts are generally too small to allow for use of strain gages or ultrasonic stretch measurements to confirm fastener preload.

For these applications, a torque-angle signature curve for tightening is recorded, then the parts are put in an environmental chamber and load/ temperature cycled.

Following the test load cycle the release angle signature is recorded. Analysis of the release-angle signature in comparison to the tightening signature is used to directly estimate the percentage of initial of clamp load lost due to embedment or creep of the plastic part in response to applied loads or temperature cycles. By changing geometric shapes and washer size, the effects can be quantitatively measured and compared.

3.6 Measurements Verify Fastener Torque and Tension

Torque-angle signature analysis is particularly useful for studying all critical fastener assemblies where it is important in terms of safety or reliability that proper preload is initially obtained and maintained throughout the operating life of an assembly.

Threaded fasteners are an important element in the product assembly process for many industries such as automobile, truck, aircraft, aerospace, machine tool, and construction. In the hands of a skilled operator, signature analysis methods can accurately estimate preload or tension within 5 percent or better.

In addition to analyzing fastener problems such as loosening and embedment, torque-angle signature analysis can also be used to evaluate the performance of tightening tools in applying the desired clamp force on fasteners. This technique is particularly applicable for evaluating pulse tools and impact tools.

Due primarily to ergonomic considerations pulse tools have recently been extensively evaluated for use in high volume assembly operations. Unfortunately, the limitations of these tools related to their energy transfer characteristics are not generally well understood. The tightening results in terms of torque-tension or achieved preload are very much dependent upon the joint friction and spring rates.

Pulse and impact tools are particularly sensitive to joint rate and friction variations. Since friction coefficients are a function of velocity as well as surface pressure tightening results with pulse and high RPM tools must be carefully evaluated to ensure suitable tightening process capability.

Pulse and impact tools move fasteners at high speeds with a great deal of stick-slip, chatter, and unique frictional characteristics that are not seen with steady, continuous tightening processes. These factors can lead to a deceptively high torque reading but with minimal clamp force created. By checking the assembled joint with a release angle study, the user can ensure that an adequate angle of turn, and thus proper clamp force, is being achieved.

Clearly this method of audit provides a direct measure of the capability of a given tool to develop tension in the tightened fastener. The results of release angle audits, being directly related to the tension achieved, are significantly more meaningful than the torque magnitudes obtained from breakaway torque audits. An improved version of the breakaway torque audit, which uses the torque-angle signature of the audit, can be used to directly estimate fastener tension. This analysis process correlates precisely with the release-angle signature method. The only limitation is that the breakaway audit must be conducted in the elastic-tightening region for the bolted joint where bolt yield or thread strip are not present.

The following series of tightening, breakaway torque audits and release signatures illustrate the basic concepts of torque and tension audit using torque-angle signatures. Understanding of the engineering mechanics of threaded fasteners is greatly enhanced through use of the concept of the "Elastic Origin" and the application of M-Alpha and F-Alpha diagrams to the audit process.

In the example illustrated in Figure 37, the M12 x 1.75 fastener was tightened to 60 lb-ft (81 Nm). The signature has been recorded with a "record threshold" of 20 lb-ft (27 Nm). The plot shows both torque and tension vs. angle of turn, with "0" angle located at the threshold.

Figure 37. Torque & Clamp Force vs. Angle

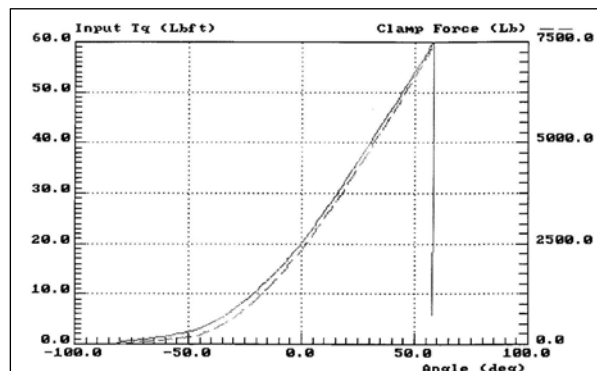

The signature analysis software can automatically locate the "elastic origin" on the M-Alpha Diagram by projecting a tangent line from the final point on the torque-angle curve to the "0" torque or, if present, the prevailing torque level.

The M-Alpha Diagram for the installation tightening signature, shown in Figure 38, illustrates that the torque resulted in a projected elastic tightening angle of approximately 85 degrees, resulting in a clamp force of about 7,500 lb (33,360 Nt.).

Figure 38. M-Alpha Diagram from SR1, VDI-2230

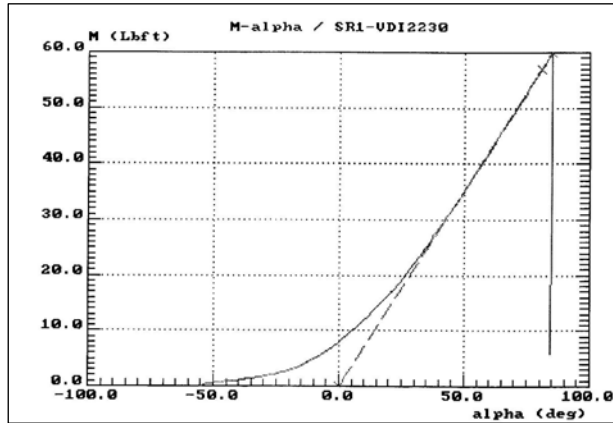

The next signature is the "breakaway" torque audit, shown in Figure 40, on the bolted joint tightened for the example shown in Figure 39.

Figure 40. Breakaway Torque Audit

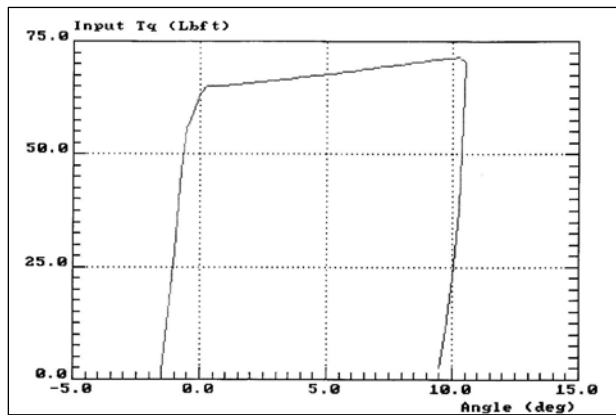

The signature analysis diagram shown in Figure 41 is one of the most significant analysis tools developed in the past 10 years. This diagram shows how it is possible to audit both installation torque and correlate the signature of the audit curve directly with fastener tension. The projection of the tangent to the torque-angle signature curve that locates the "elastic origin" is the key to significant improvement of the hand torque audit process.

Figure 41. Breakaway Audit M-Alpha from SR1, VDI-2230

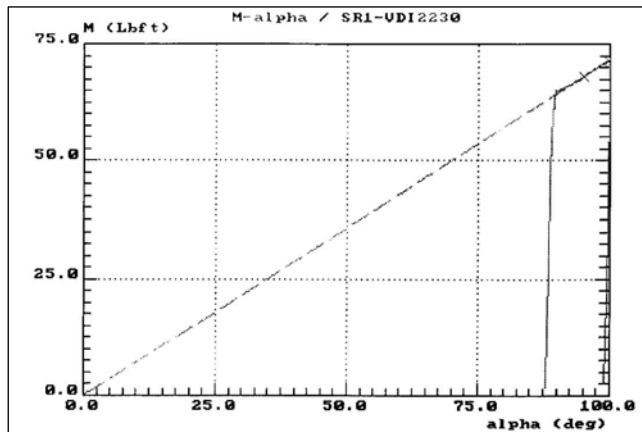

released can be directly estimated if the F-Alpha slope for the joint has been established.

The corresponding F-Alpha curve, shown in Figure 39, confirms the relationship between torque and angle with the concept of the "elastic origin". Note that the 85-degree elastic-tightening angle for the bolt results in approximately 7,500 lb. (33,360 Nt.) clamp force.

Figure 39. F-Alpha Diagram from SR1, VDI-2230

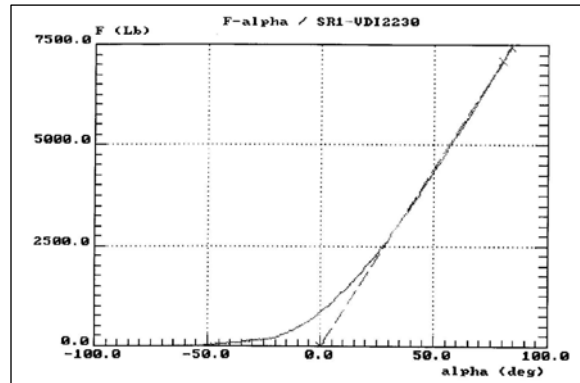

Breakaway hand torque audits are often used to attempt to correlate dynamic installation torque with the measured breakaway point. In this example, the fastener was torqued in the tightening direction until an additional angle of turn of about 12-13 degrees was attained. Note that the head of the fastener started to move at about 55 lb-ft (74.5 Nm). Actual breakaway and continuation of the tightening process occurred at about 65 lb-ft (88 Nm) of applied torque. These observations confirm the installation torque of 60 lb-ft (81 Nm) as is normally done for a breakaway torque audit.

The M-Alpha Diagram for the audit signature clearly shows the torque breakaway point related to the installation torque, and also shows the 85 degree initial tightening angle which correlates with a pre-load of 7,500 lb. (33,360 Nt.) clamp force. Note that the breakaway audit increased the tightening angle to approximately 95-100 degrees projected from the elastic origin, with an expected proportionate increase in preload.

If the release torque-angle signature is recorded when a fastener is loosened, as shown in Figure 42, the elastic tightening angle can be estimated, and thus the approximate fastener tension

Figure 42. Release Signature

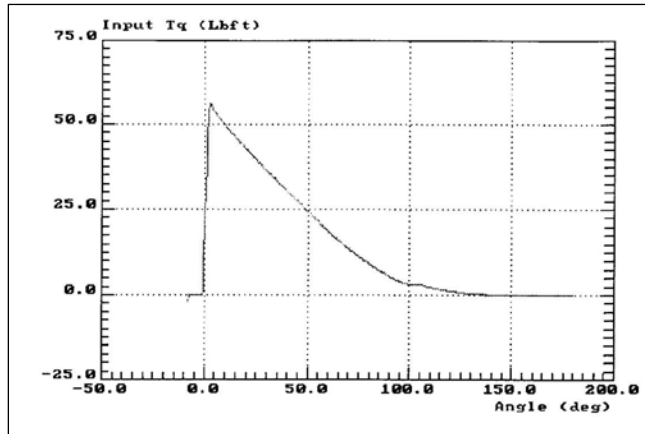

M-Alpha plots and release-angle plots can be used to directly estimate bolt tension, or preload, which is the ultimate goal of the fastener tightening process. In the example shown in Figure 50, the release angle of approximately 95 degrees confirms the tightening angle measured on the M-Alpha Diagram for the hand torque audit.

To continue the examples of torque-angle-signature analysis to audit installation torque and preload, the original fastener used in the initial example above was stripped of all thread and underhead lubricants to create higher friction co-

efficients in the thread and underhead regions. The M-alpha diagram for tightening to 60 lb-ft (81 Nm), shown in Figure 43, indicates a tightening angle of only 25 degrees projected from the elastic origin. Compared to the lubricated fastener where the tightening angle was 85 degrees the predicted preload of 2200 lb. (9786 Nt.) was confirmed by the clamp force measurement.

Figure 43. M-Alpha Diagram, Tightened Dry

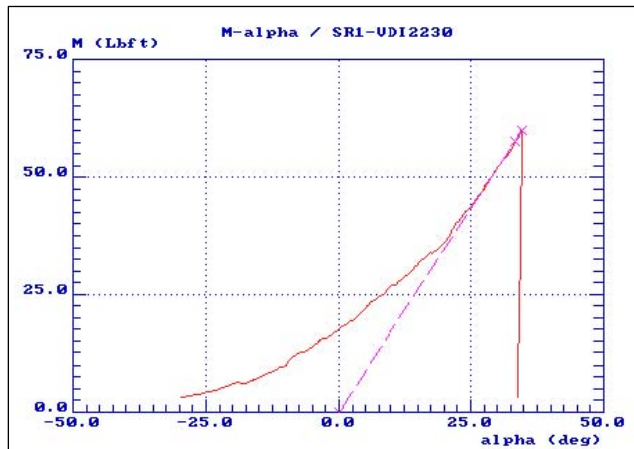

The breakaway audit for the "dry" tightened fastener, shown in Figure 44, confirms that the installation torque was approximately 60 lb-ft (81 Nm), and also reveals the expected very low angle of turn from the elastic origin.

Figure 44. Breakaway M-Alpha Diagram, Dry Fastener

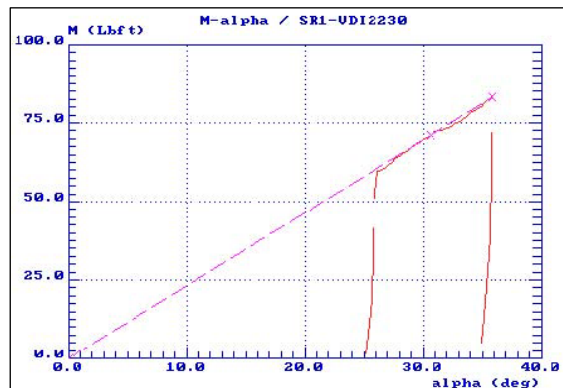

The torque-angle signature method of analysis applied to tightening and loosening curves is plain, simple, and straightforward. It is a basic engineering analysis technique using fundamental stress, deflection and material strength properties to model and measure the bolted joint tightening process. The torque angle signatures can be analyzed to determine installation torque, thread strip, underhead embedment, bolt yield, and most important, fastener tension. The M-Alpha plots with reference to the elastic origin are directly linked to the SR1 Bolted Joint Design software for Windows 95.⁹

The technique can be applied to fasteners of all sizes and all grip lengths. While there may be 75 to 100 factors that can alter the tightness of a given bolted joint, the torque-angle signature analysis method provides a practical method for direct verification of clamp force to assure a quality fastener assembly.

In addition to direct estimation of tension achieved it is possible for the signature analysis method to detect bolt yield, thread strip and embedment problems. The release-angle signature when compared to the installation torque-angle can be used to evaluate the clamp load retained after a dynamic test.

⁹ SR1 Bolted Joint Design Software, Version 6.1+ from RS Technologies, a division of PCB Load & Torque, Inc., Farmington Hills, Michigan, USA

Material creep and embedment phenomena, which lead to loss of pre-load, are readily analyzed and quantitatively evaluated through use of the release-angle analysis methods.

The methods are particularly powerful in evaluating and comparing the tightening capability of various manufacturers pulse tools for application on a given assembly or bolted joint.

4.0 Other Strategies

4.1 Torque-Turn-To-Yield

All advanced tightening strategies use both torque and angle of turn to develop clamp force. The most common application of torque-angle control is the use of a combination of torque and turn-to-yield steps to achieve the maximum clamp force that a given fastener is capable of attaining.

In torque-turn-to-yield tightening, the fastener is first tightened to a torque level that achieves 60-80 percent of the yield tension. This is followed by an additional angle of turn, usually 90-100 degrees.

While most properly manufactured, high strength fasteners can be tightened to yield, unless the fastener manufacturer has specifically designed the fastener to be installed with a yield tightening process use this method with care.

True yield fasteners have a reduced cross-section between the thread and head, where the yielding occurs before permanent set occurs in the thread section. Common fasteners tightened to yield usually yield in the threads, creating pitch elongation that makes re-use of such fasteners undesirable.

Fasteners tightened beyond the yield point exhibit strain hardening, yielding at progressively higher torques each time they are re-used. If the thread and underhead frictions do not change the clamp forces attained also increase progressively with each subsequent tightening cycle until the elongation capability of the bolt is exceeded and failure occurs. Certain yield-bolt designs are reported to be capable of 5-6 re-tightenings.

4.2 Prevailing Torque Locknut Signature Analysis

A method of estimating the clamp force achieved when tightening fasteners with prevailing torque is illustrated in Figure 45. In the special case of prevailing torque fasteners, the elastic origin is located at the prevailing torque level not zero torque. Clamp force is proportional to the angle of turn, α , from this point.

Figure 45. Estimating Clamp Force with Prevailing Torque

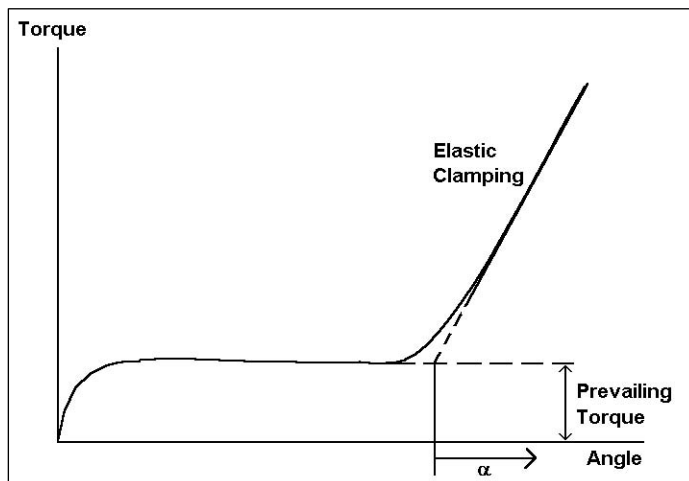

4.3 Hand Torque Tightness Quality Audits

Since the desired result is proper fastener tightness or tension, the ideal audit process would directly determine the tension in the fastener. However, since it is not practical to put strain gages on production assemblies or use force washers under the head of each bolt, other techniques had to be developed.

Ultrasonic techniques for measuring bolt stretch have proven useful in some applications, but there are practical limitations for this method as appears to be the case with most known tension audit processes.

For the last twenty years or more it has been common practice to use hand torque wrenches to audit the tightness of threaded fasteners. The operator re-torques the fastener by applying a tightening force until he feels the fastener move. Then he stops and notes the torque level on the wrench's indicator. Unfortunately, this measuring technique is highly operator sensitive. The amount of "overshoot" depends on how quickly the operator responds once he senses that motion has occurred.

The torque-angle plot of the fastener tightening process is the key tool for analysis of the tightening process. Similarly, the torque-time plot of the hand torque audit process is the key to proper specification and design of electronic hand torque audit equipment.

Microprocessor-based audit systems must be programmed to detect and analyze torque-time profiles so that significant data points, which correlate with the known torque-tension relationship, are recorded. In order to properly program and obtain useful information with a hand torque audit instrument, it is necessary to know both what the torque-time signal profile is as well as to which factor the audit instrument has been programmed to respond.

Experimental studies made during the past several years have shown that the most useful torque reading that can be obtained with a hand torque audit, occurs at a break point just prior to the start of the turning motion of the fastener thread. This break point or breakaway torque value is a characteristic of fasteners with well-lubricated threads and underhead areas. Such torque-tension characteristics exhibit relatively small scatter and thus more uniformity than found with poorly lubricated threads and underhead regions. Breakaway torque value is a characteristic of fasteners with well-lubricated threads and under-head areas. Such torque-tension characteristics exhibit relatively small scatter and thus more uniformity than found with poorly lubricated threads and under-head regions.

4.3.1 Redefining the Audit

Using a conventional hand torque wrench to audit fasteners is not only operator dependent, it actually provides a higher torque reading—a peak torque value—rather than the true breakaway torque. When microprocessor-based instruments were introduced, some companies simply replaced the mechanical torque wrench with an electronic wrench and data collector and continued to provide peak torque measurement. As an improvement, others suggested that an angle encoder could be used to determine when the fastener head moves. However, because encoders typically work in one-degree increments, this method is not practical. One degree is about three times as far as you want the fastener to move to accurately determine the breakaway point. This can result in errors of 35 percent or more.

During breakaway testing, force washers were used to monitor the clamping force and act as an indicator for the breakaway point. The test records clearly showed that the breakaway involves two separate breaks. This result is easily predicted when you consider that the first break occurs when the underhead friction is overcome.

After the underhead friction is overcome and the shank of the fastener absorbs a slight additional torsional wind-up, the thread friction is overcome permitting added elongation and tensioning to occur.

Figure 46. Torque-Time Signature with Good Lubrication

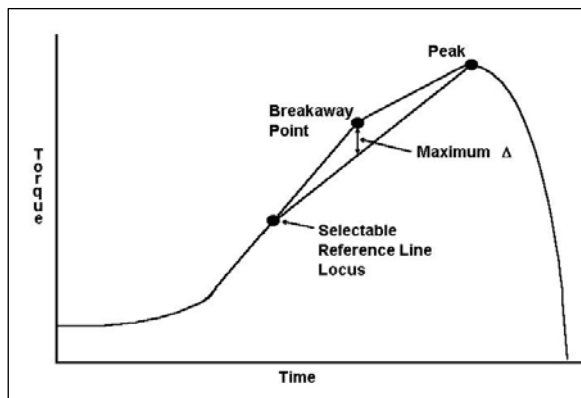

Fasteners installed with well-lubricated underhead areas and threads exhibit a smooth shift in the torque-time curve at breakaway as illustrated in Figure 46. Fasteners with poor lubrication do not. There can be a sharp break and the torque can actually decrease momentarily before increasing again as shown in Figure 47.

Figure 47. Torque-Time Signature with Poor Lubrication

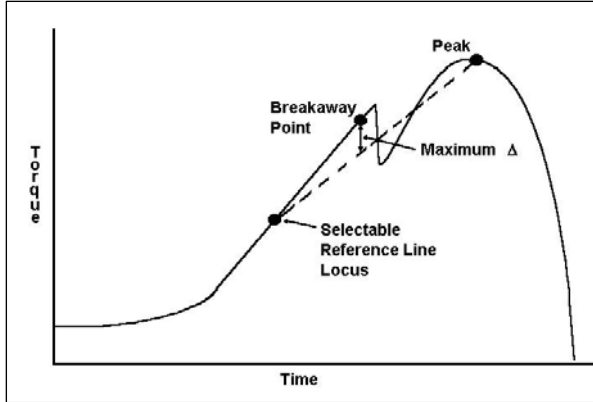

The significance of the fastener performance recorders in the development and testing programs cannot be overemphasized. Perhaps one of the most important observations that has surfaced in testing programs was that well lubricated fasteners exhibit a breakaway torque-time signature with a smooth break point compared to poorly lubricated fasteners which exhibit a “snap” or sharp drop at the break point.

The significance of this difference in signature is clear when we observe that for the same applied torque, a fastener with poorly lubricated surfaces

may develop 50 to 70 percent less tension. A conclusion we have made as a result of testing is that the break point for a well-lubricated fastener occurs at the value of the installation torque, provided that no relaxation has occurred in the joint. Thus, the quality of the fastener tensioning process can be judged by proper interpretation of the torque-time breakaway curve.

Through use of microprocessors in portable data collectors, we have now been able to significantly improve the art of hand torque auditing, by applying careful study of fastener performance characteristics and using the calculating power of the microprocessor.

One common mistake that is still being made is the attempt to qualify and demonstrate capability of modern fastener installation equipment through the use of old-fashioned hand torque readings. While it is possible that peak hand torque readings may occasionally correlate with measured dynamic installation torques, such attempts are clearly flawed, if only due to the overshoot error introduced by the operator. The break point analysis method, either with a torque-angle transient recorder or a properly programmed microprocessor based instrument is the preferred state-of-the-art correlation technique.

Torque angle audit signatures can be evaluated for estimating the clamp force by locating the elastic origin through projection of the tangent line of the curve after the breakaway point. When auditing is done in the tightness direction, the tightening process is continued after the breakaway point. This procedure makes practical use of the natural overshoot of the break point. Refer to Figures 48 and 49.

Figure 48. Projection to Elastic Origin, Good Lubrication

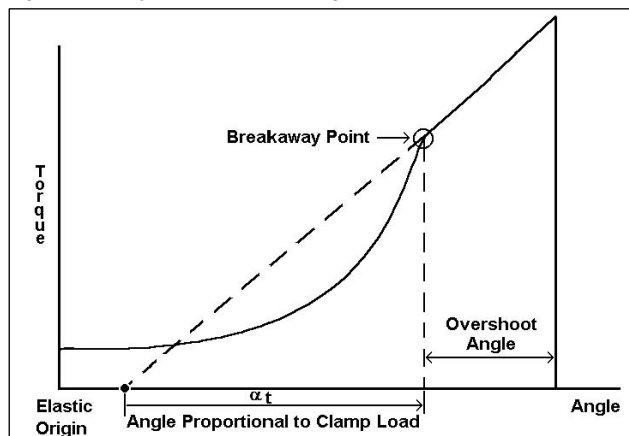
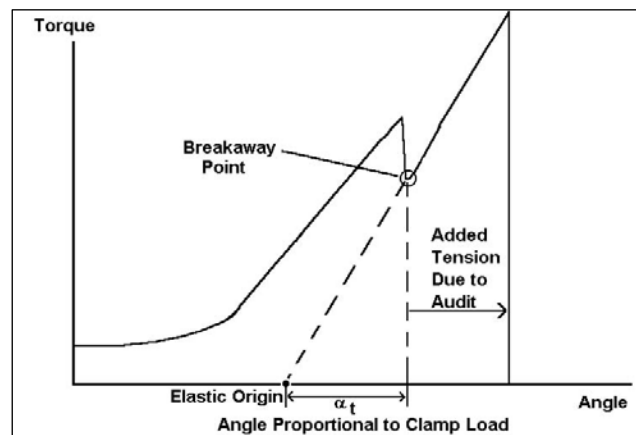

Figure 49. Projection to Elastic Origin, Poor Lubrication



4.3.2 Hand Torque Audit Qualification

It is recommended that the torque-time signatures of all hand torque audit tests be recorded and reviewed prior to specification of equipment and setting numerical limits for such tests. A proper test should always include torque-angle and or torque-time signature analysis of the installation process. This is absolutely necessary before any meaningful correlation factor can be established between installation and audit records.

The release angle torque-tension audit procedure, described in paragraph 3.4, is perhaps the most powerful and practical method of evaluating the actual clamp force achieved by an installation process.

5.0 Using Torque Angle Records to Determine Joint Stiffness

Use the following procedure to determine joint stiffness through analysis of torque-angle records.

1. Record the torque-angle curve.
2. From the linear elastic range after snugging, determine the clamping torque range, T_c , and the total clamping angle, α_t , as shown in Figure 50.

Figure 50. Clamp Torque and Angle, Effective Bolt Length

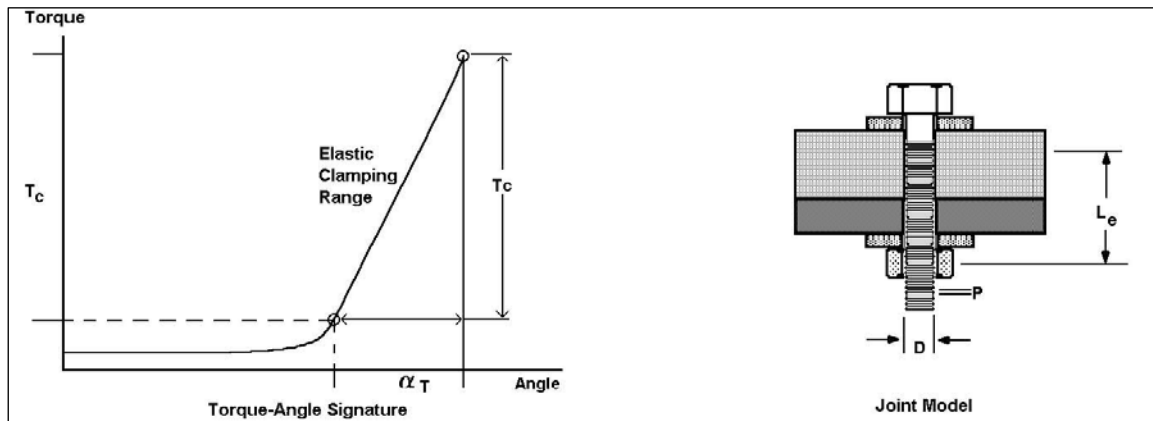

3. Assume a value for K, i.e. $K = 0.18$.
4. Calculate F_c using the following formula.

$$F_c = \frac{T_c}{KD}$$

5. Assume effective length of bolt, L_e .
6. Calculate bolt elongation using the following formula.

$$\delta_b = \frac{F_c L_e}{AE}$$

7. Calculate the turn-to-elongation angle, α_b .

$$\alpha_b = \delta_b \frac{360}{P}$$

8. Model the Force/Deformation and Torque-Angle Diagram (refer to Figure 9 and related discussion).

9. Perform Spring Rate Analysis to equate the relative angular and linear deformations.

$$K_b = \frac{F}{L_b} LB / INCH \quad K_c = \frac{F}{\delta_c} LB / INCH$$

$$\delta = \frac{F}{K_b} + \frac{F}{K_c} = F \left(\frac{1}{K_b} + \frac{1}{K_c} \right) = F \left(\frac{K_b + K_c}{K_b K_c} \right)$$

$$\delta = F_c \left(\frac{K_b + K_c}{K_b K_c} \right) = \alpha_t \left(\frac{P}{360} \right)$$

10. Calculate the deformation, δ_c , of the clamped parts.

$$\delta_c = \delta_t - \delta_b = \alpha_t \left(\frac{P}{360} - \frac{F_c L_e}{AE} \right)$$

11. Estimate the spring rate of the bolt and clamped parts.

$$K_b = \frac{F_c}{\delta_b} \quad K_c = \frac{F_c}{\delta_b}$$

12. Estimate the preload efficiency factor.

$$\Phi = \frac{K_b}{K_b + K_c}$$

NOTE: For VDI-2230, $FSA = \Phi FA = \Delta F = \Delta F_e$. Refer to the following formulas for rearranging terms.

$$K_b = \frac{F}{\delta_b} = \left(\frac{T}{KD} \right) \frac{360}{P} \frac{1}{\alpha_b}$$

$$K_c = \frac{F}{\delta_c} = \left(\frac{T}{KD} \right) \frac{360}{P} \frac{1}{\alpha_c}$$

$$\Phi = \frac{\frac{1}{\alpha_b}}{\frac{1}{\alpha_b} + \frac{1}{\alpha_c}} = \frac{1}{1 + \frac{\alpha_b}{\alpha_c}}$$

$$\Phi = \frac{1}{1 + \frac{\alpha_b}{\alpha_c}}$$

The variable bolt load, ΔF , due to an external load, F_e , is found by multiplying the efficiency factor, Φ , by the applied external load, i.e., $\Delta F = \Phi F_e$.

6.0 Material Yield Point

The chart shown below in Figure 51 can be used to estimate the minimum angle of turn which will be required to stretch a fastener to the material yield point. The chart assumes that the clamped components have infinite stiffness.

Figure 51. Minimum Turn per Inch of Length vs. Thread Pitch

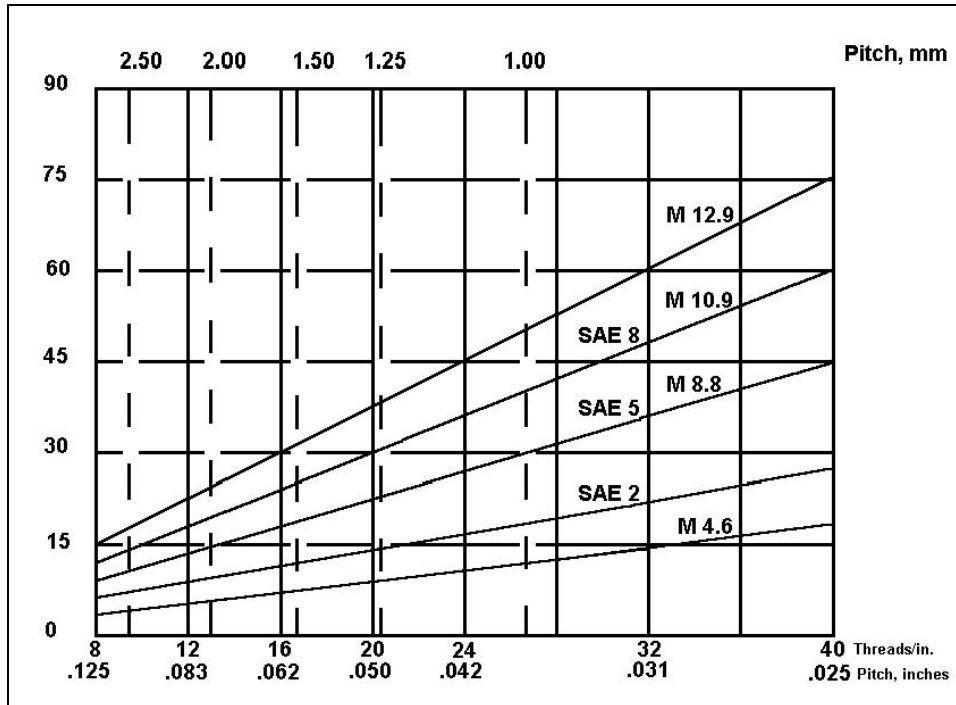

7.0 Glossary of Important Terms

The following terms, which may be unfamiliar to some readers, are used throughout this paper and are defined below.

- D_{km} Effective diameter for the friction in the bolt head or nut bearing area (in., mm)
- F Force, general (lb., Nt.)
- F_M Initial clamping load (assembly preload); the values in the table are calculated with a 90 percent utilization of the elastic limit using σ_{red} (lb., Nt.)
- F_V Preload general (lb, Nt.)
- K Nut Factor for basic equation, $T = KDF$
- M_A Tightening torque for the assembly until preloading of bolt reaches F_M (lb-ft, Nm)
- P Pitch of the bolt thread (in., mm)
- T Torque, general (lb-ft, Nm)
- d Bolt diameter = outside diameter of thread (nominal diameter) (in., mm)
- d_h Bore diameter of the clamped parts; inner diameter of the substitution cylinder (in., mm)
- d_w Outer diameter of the plane head bearing surface (at the inlet of the transition radius of the head) (in., mm)
- d_2 Pitch diameter of bolt thread (in., mm)

μ	Coefficient of friction, general
μ_G	Coefficient of friction in thread
μ_{ges}	Average coefficient of friction for thread and bolt head bearing surface
μ_K	Coefficient of friction for bolt head bearing surface

8.0 References

The following publications are recommended for those who would like to obtain more information about the science, technology, and art of threaded fastener engineering.

John H. Bickford, *An Introduction To The Design and Behavior of Bolted Joints*. Marcel Dekker, Inc., New York (1990).

Alexander Blake, *Design of Mechanical Joints*. Marcel Dekker, Inc., New York (1985).

Alexander Blake, *What Every Engineer Should Know About Threaded Fasteners Materials and Design*. Marcel Dekker, Inc., New York (1986).

Virgil Moring Faires, *Design of Machine Elements*, third edition. The Macmillan Company, New York (1955).

P. G. Forrest, *Fatigue of Metals*. Pergamon Press, New York; Addison-Wesley Publishing Company, Inc., Reading, Massachusetts (1962).

Industrial Fasteners Institute, *Fastener Standards*, fifth edition. Industrial Fasteners Institute, Cleveland, Ohio (1970).

Industrial Fasteners Institute, *Metric Fastener Standards*, second edition. Industrial Fasteners Institute, Cleveland, Ohio (1983).

Robert C. Juvinall, *Engineering Consideration of Stress, Strain, and Strength*. McGraw-Hill Book Company, New York (1967).

Robert C. Juvinall, *Fundamentals of Machine Component Design*. John Wiley & Sons, New York (1983).

Geoffrey L. Kulak, John W. Fisher, John H. A. Struik, *Guide to Design Criteria for Bolted and Riveted Joints*, second edition. John Wiley & Sons, New York (1987).

Joseph Edward Shigley, *Mechanical Engineering Design*. McGraw-Hill Book Company, New York (1977).

For more information about this and other related Fastening Technology information and products, please contact:

RS Technologies, a Division of PCB Load & Torque, Inc.

24350 Indoplex Circle
Farmington Hills, MI 48335
Toll-Free in the USA: 888-684-2894
24 Hour SensorLine™: 716-684-0001
Fax: 248-888-8266
Email: rsinfo@pcbloadtorque.com
www.pcbloadtorque.com

